

EXPLODED DRAWING A

Model No. GGTL39610.6 R1112A

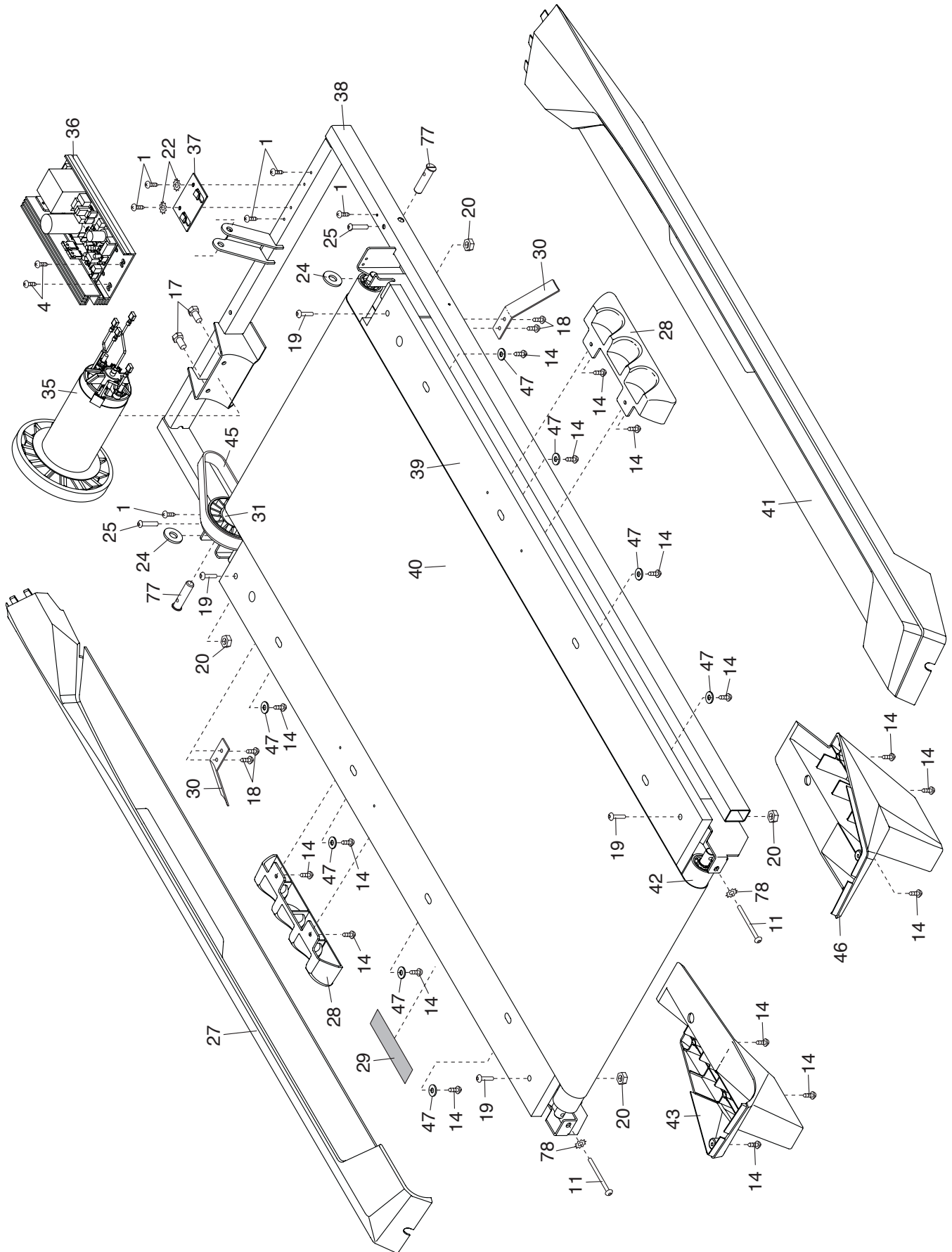

EXPLODED DRAWING B

Model No. GGTL39610.6 R1112A

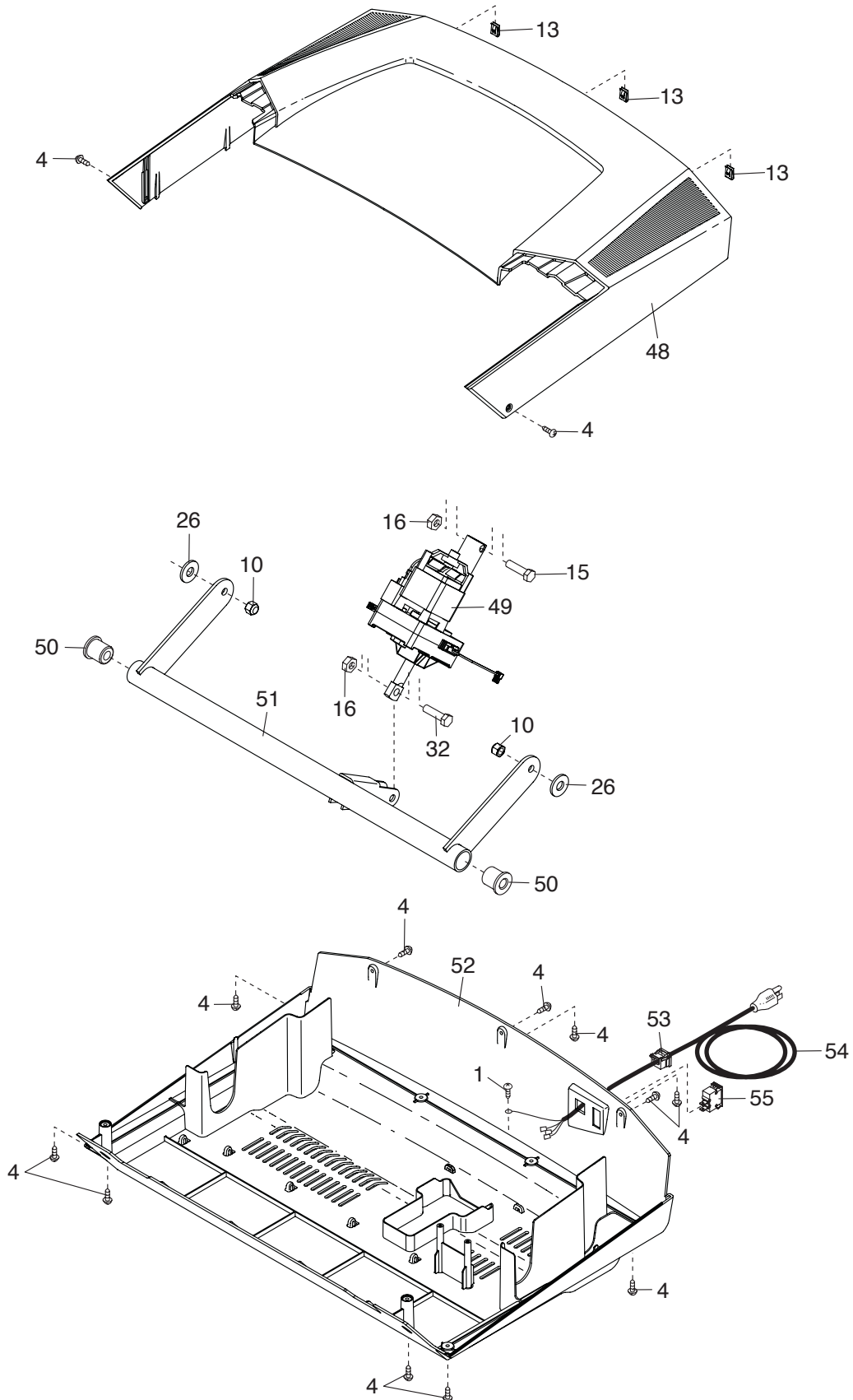

EXPLODED DRAWING C

Model No. GGTL39610.6 R1112A

