

EXPLODED DRAWING A

Model No. GGTL39614.1 R0615A

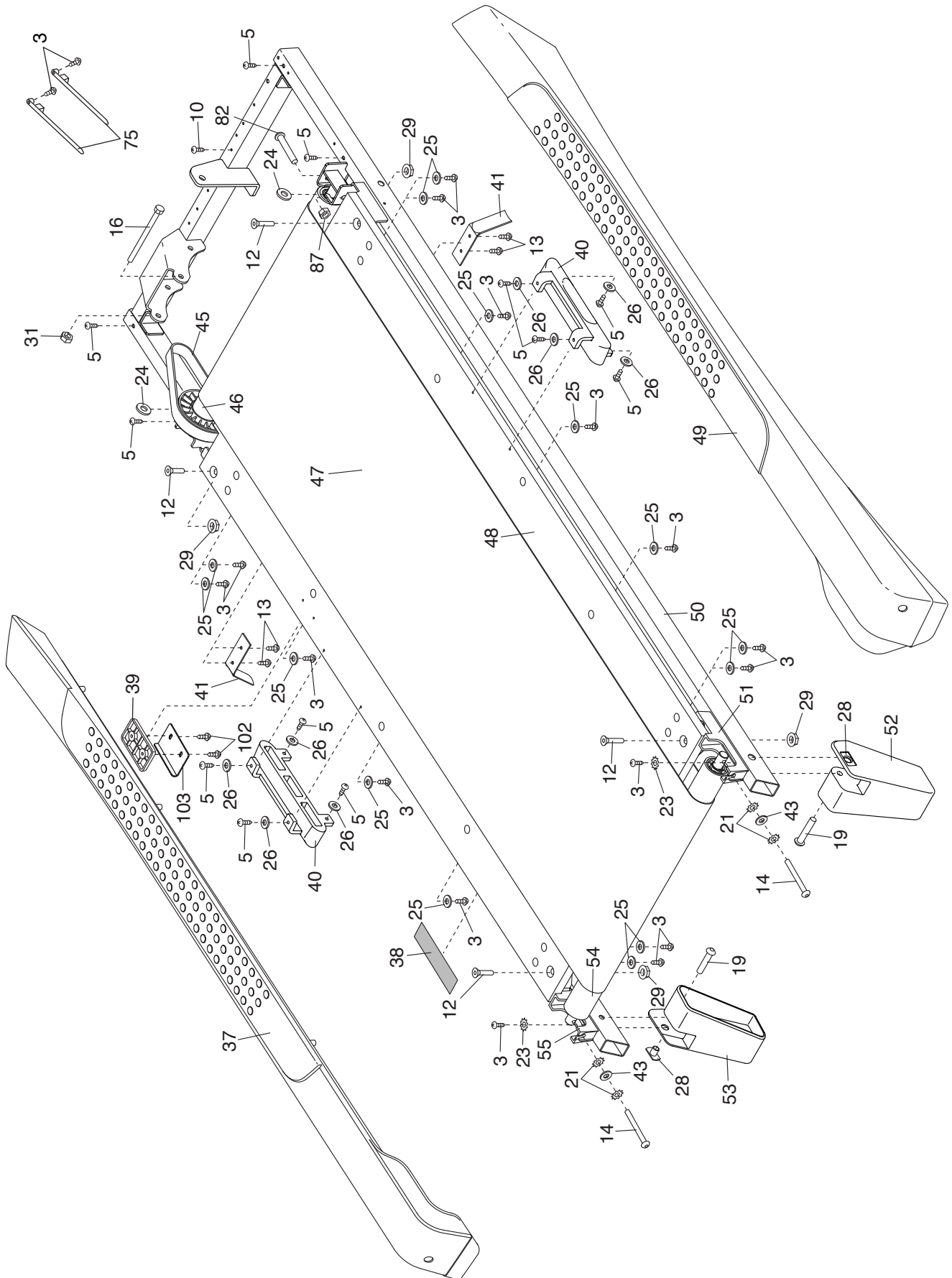

EXPLODED DRAWING B

Model No. GGTL39614.1 R0615A

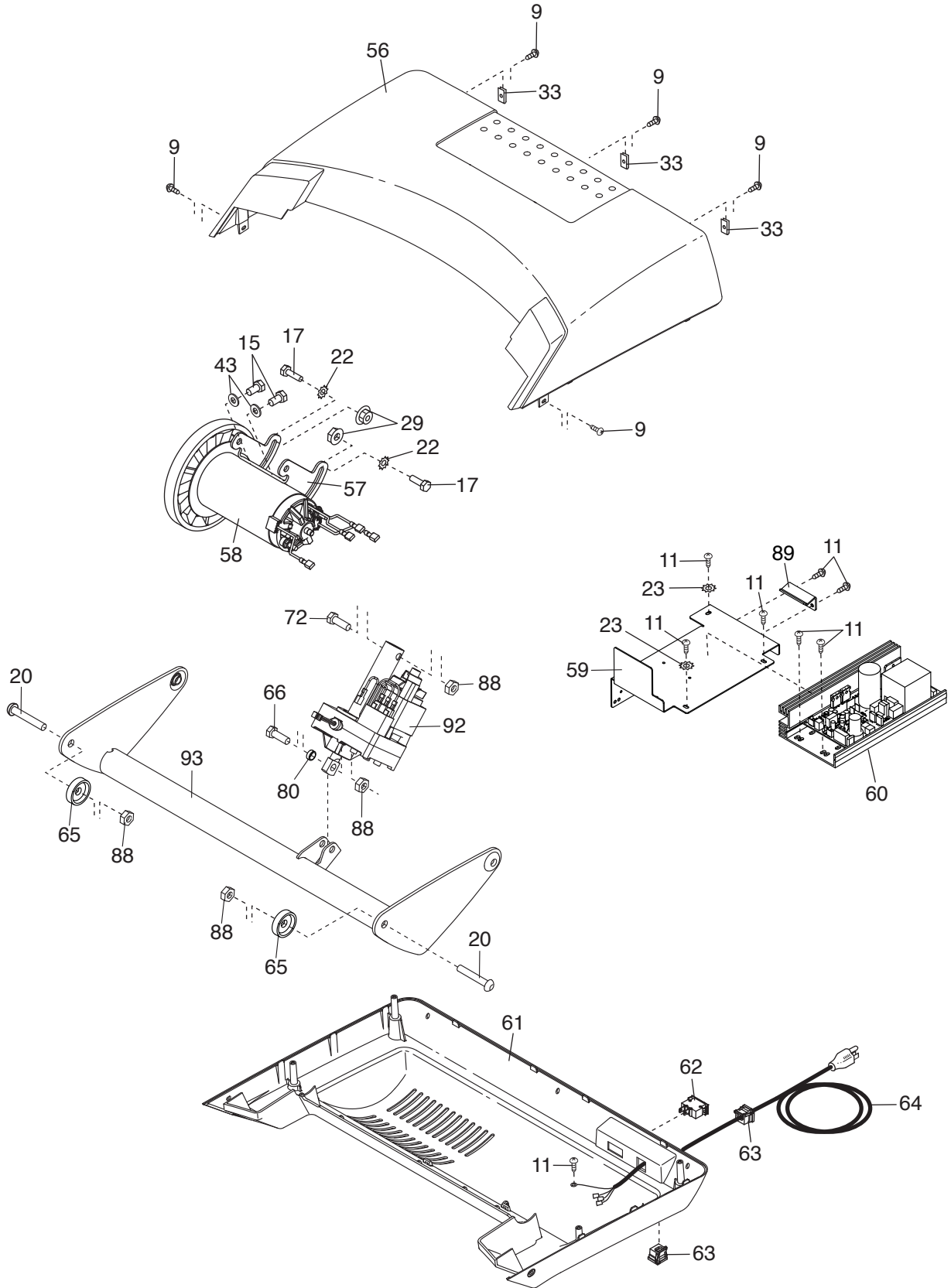

EXPLODED DRAWING C

Model No. GGTL39614.1 R0615A

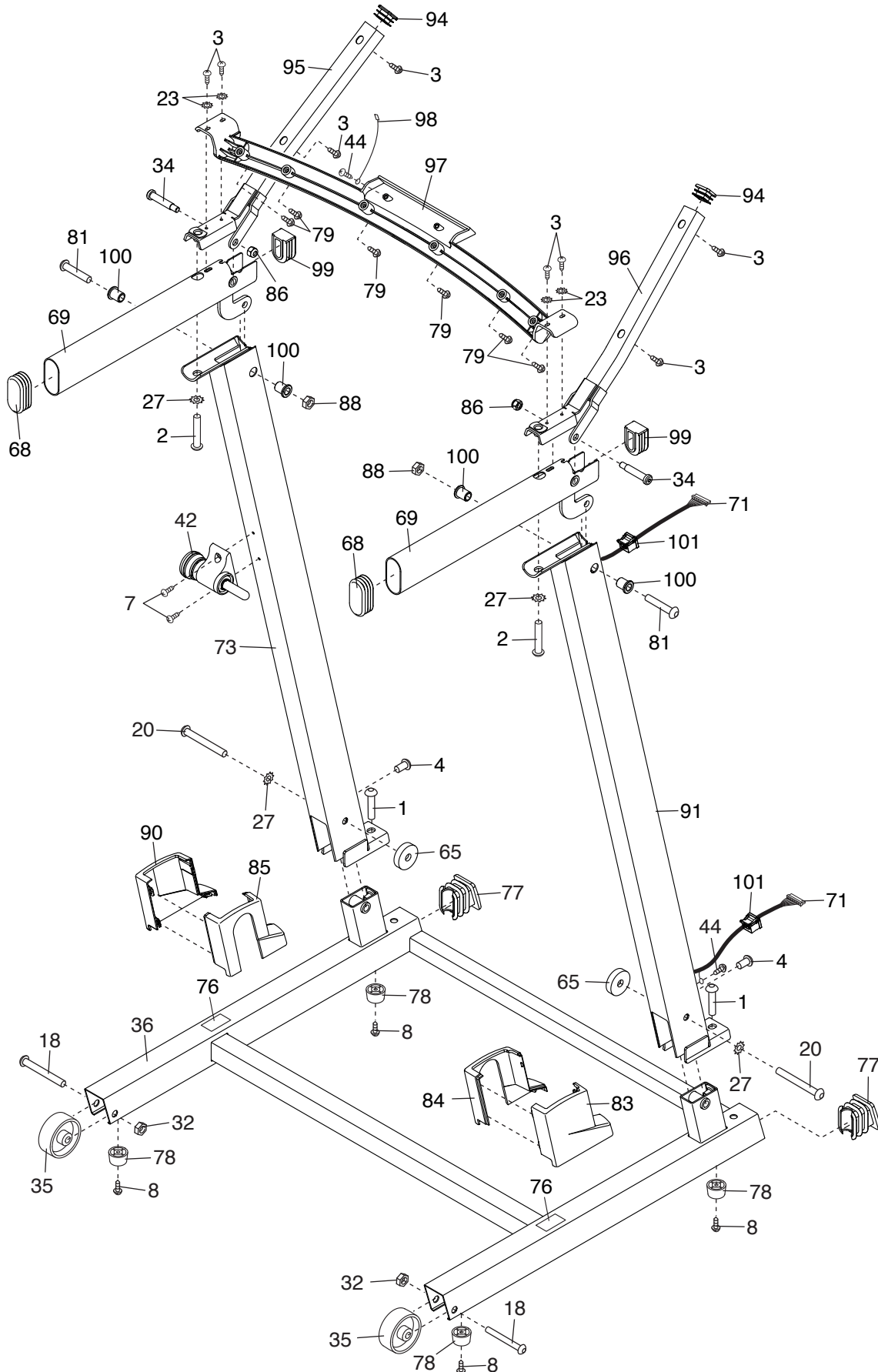

EXPLODED DRAWING D

Model No. GGTL39614.1 R0615A

