

EXPLODED DRAWING A

Model No. GGTL39615.0 R0915A

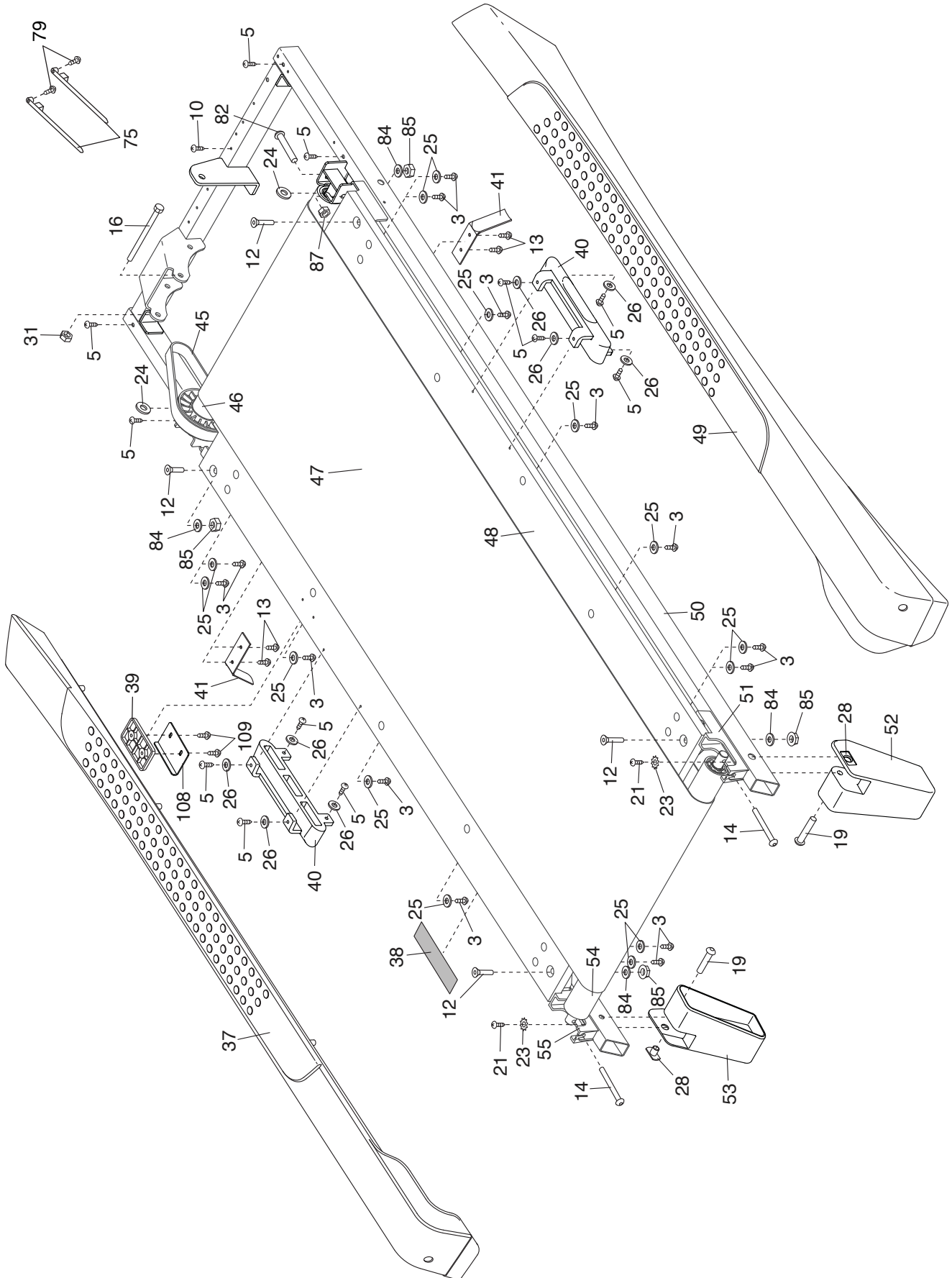

EXPLODED DRAWING B

Model No. GGTL39615.0 R0915A

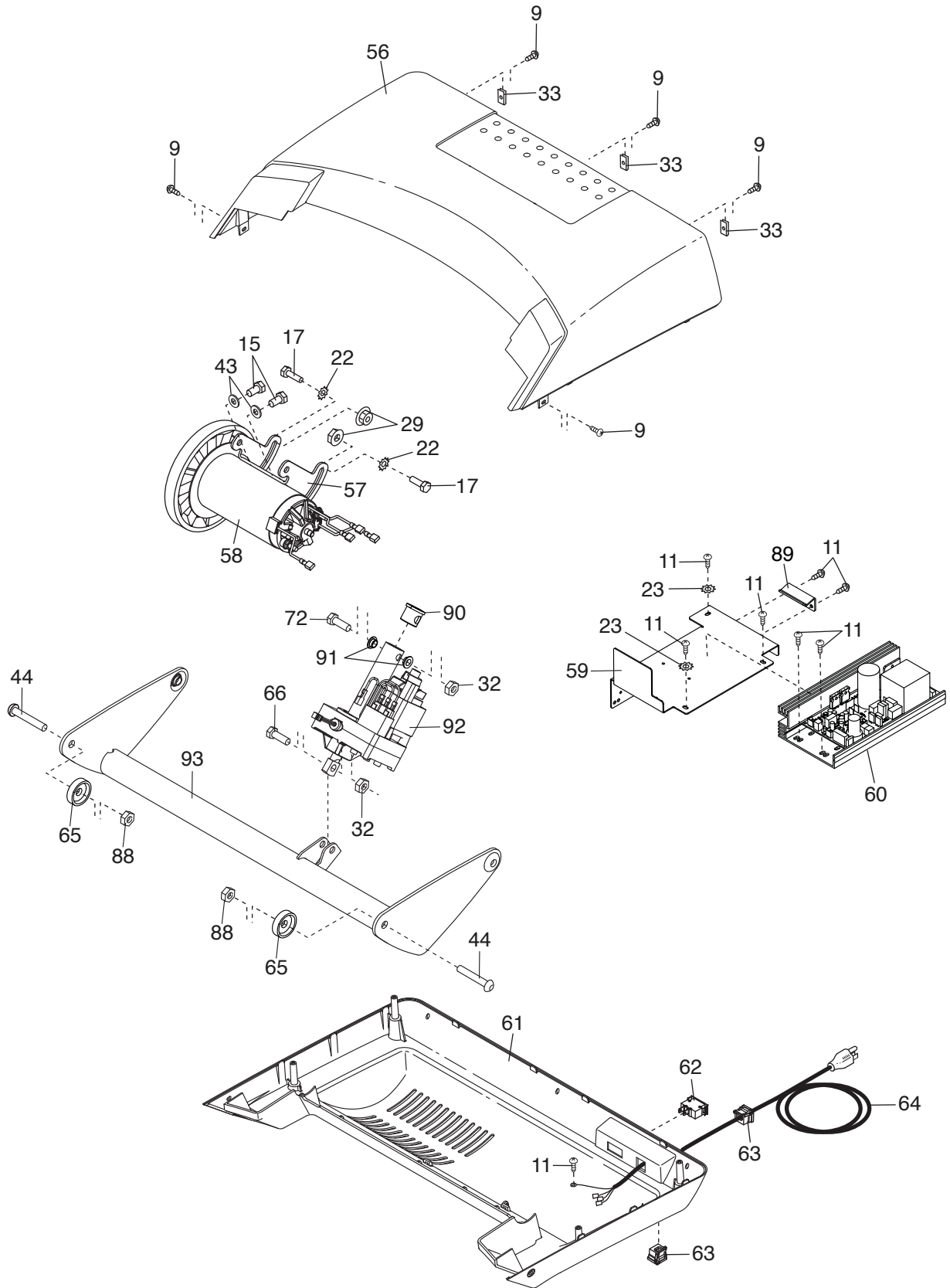

EXPLODED DRAWING C

Model No. GGTL39615.0 R0915A

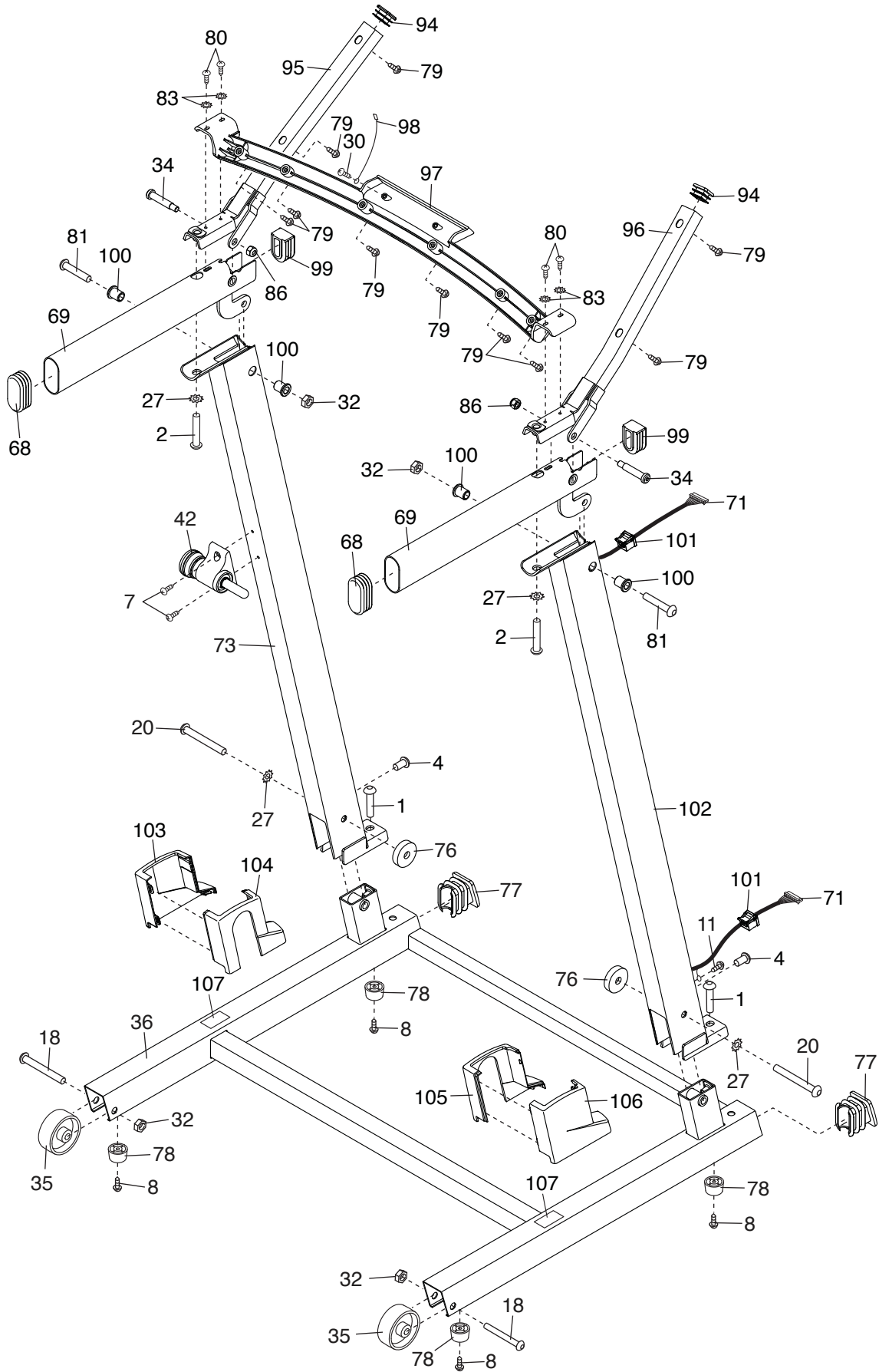

EXPLODED DRAWING D

Model No. GGTL39615.0 R0915A

