

EXPLODED DRAWING A

Model No. GGTL39617.1 R0717A

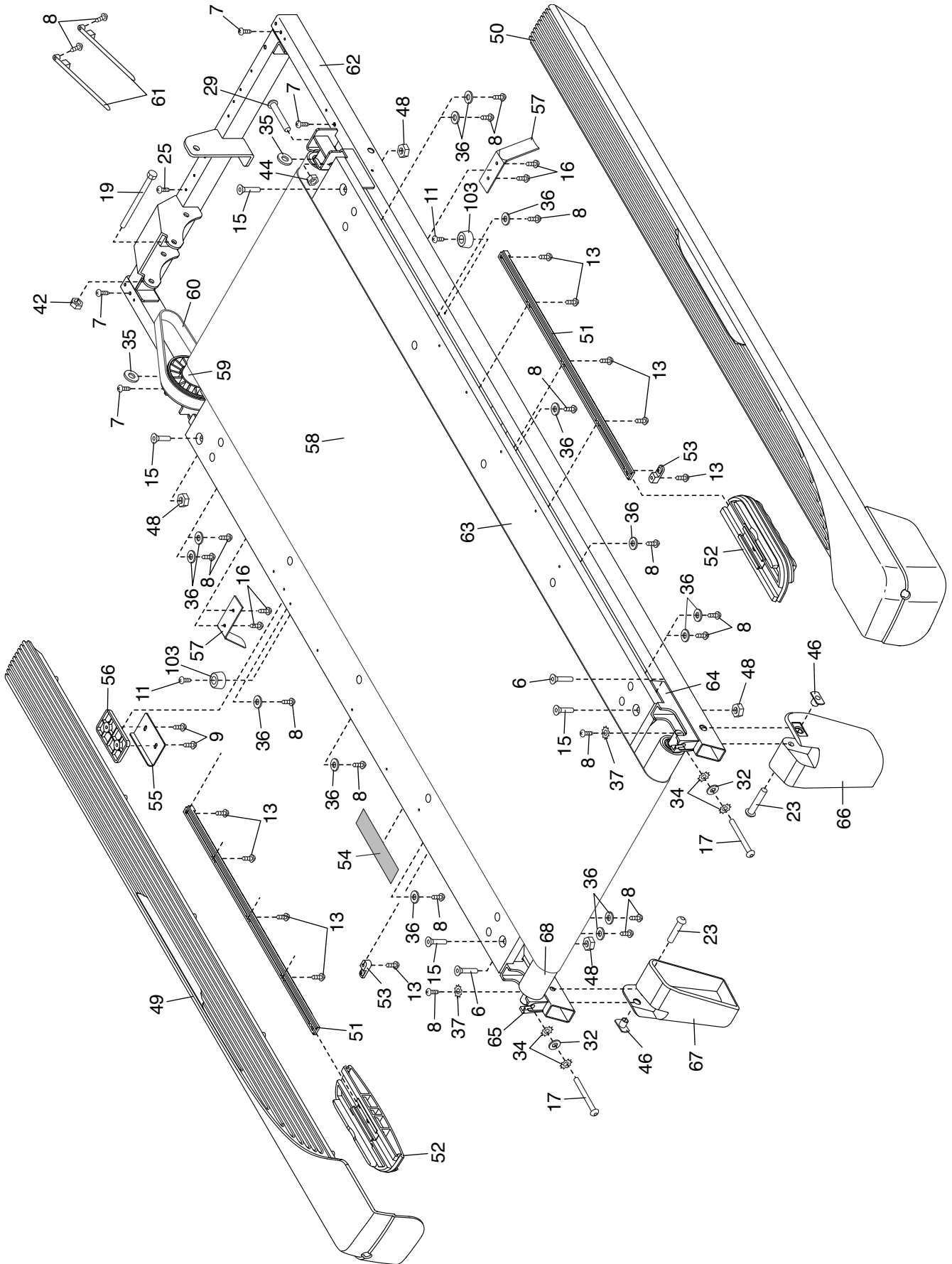

EXPLODED DRAWING B

Model No. GGTL39617.1 R0717A

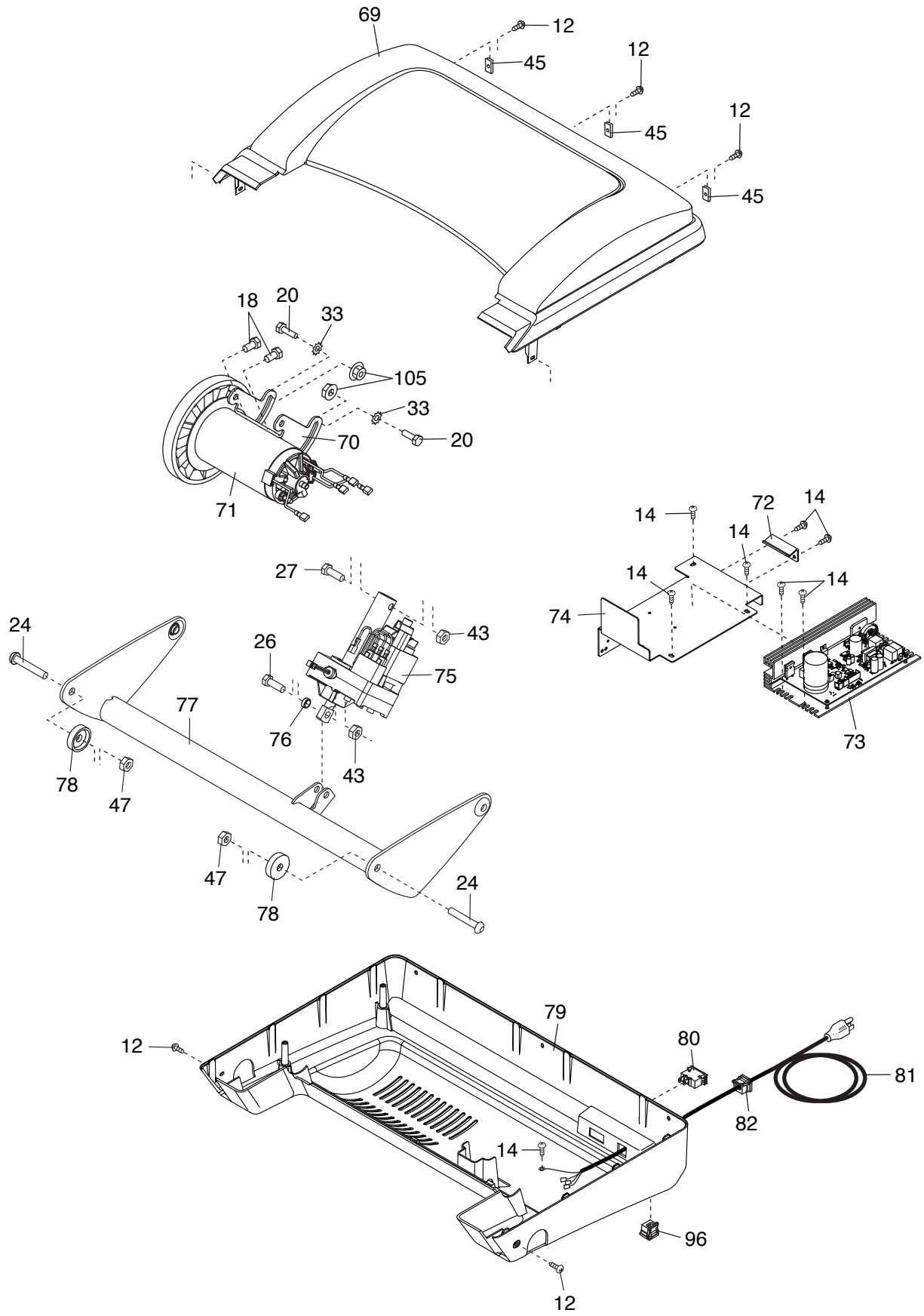

EXPLODED DRAWING C

Model No. GGTL39617.1 R0717A

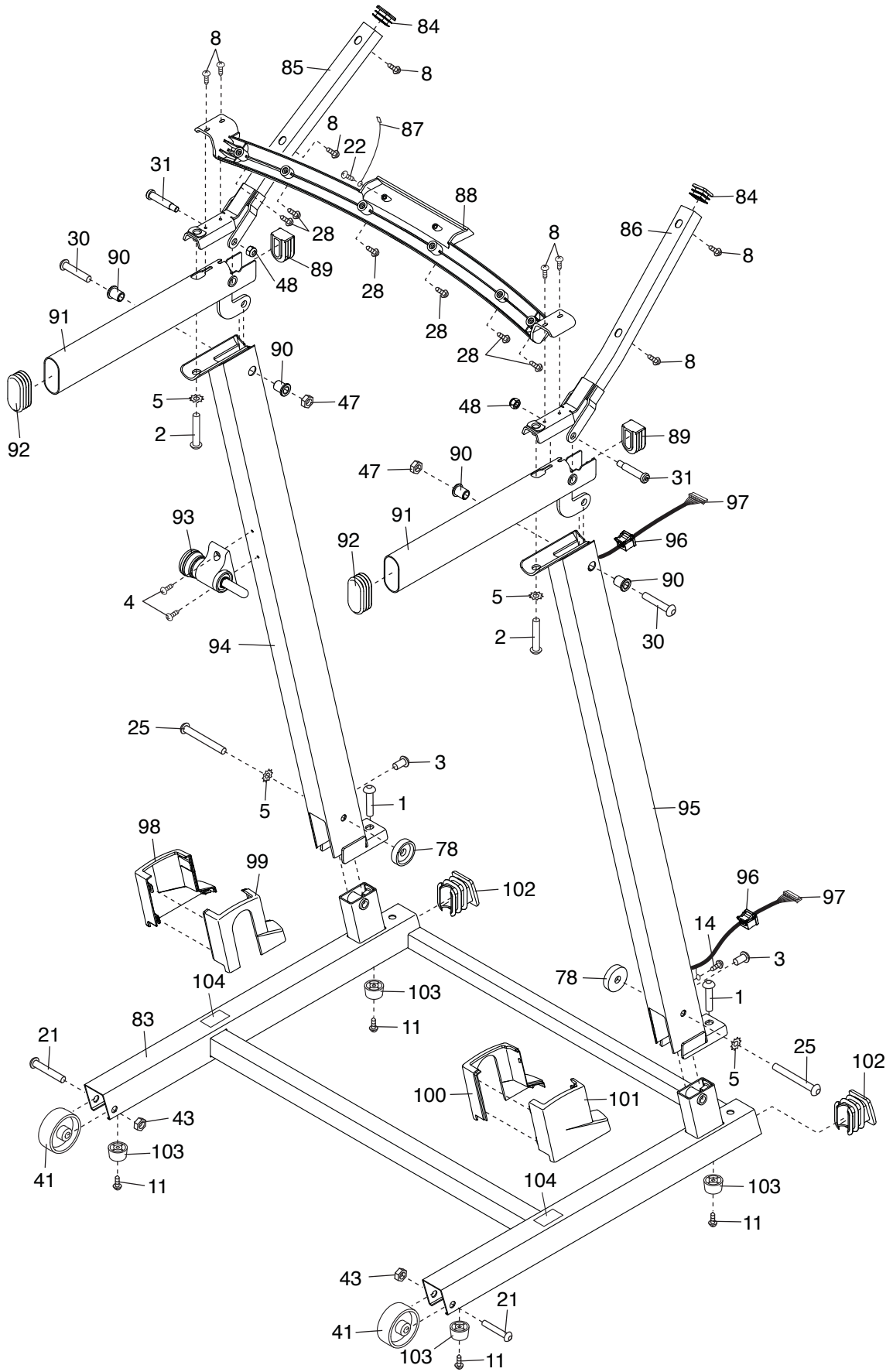

EXPLODED DRAWING D

Model No. GGTL39617.1 R0717A

