

EXPLODED DRAWING A

Model No. GGTL39617.4 R0118A

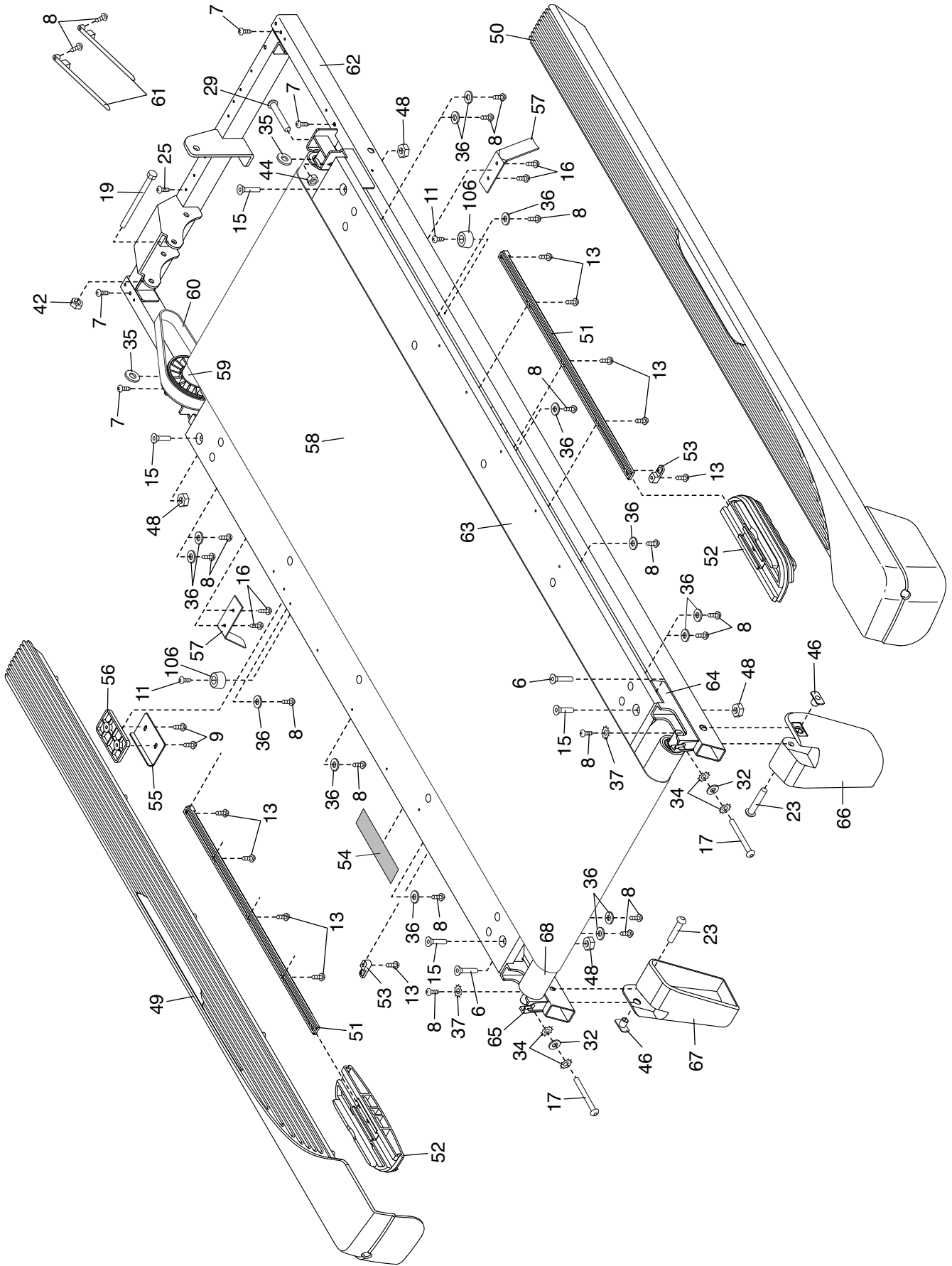

EXPLODED DRAWING B

Model No. GGTL39617.4 R0118A

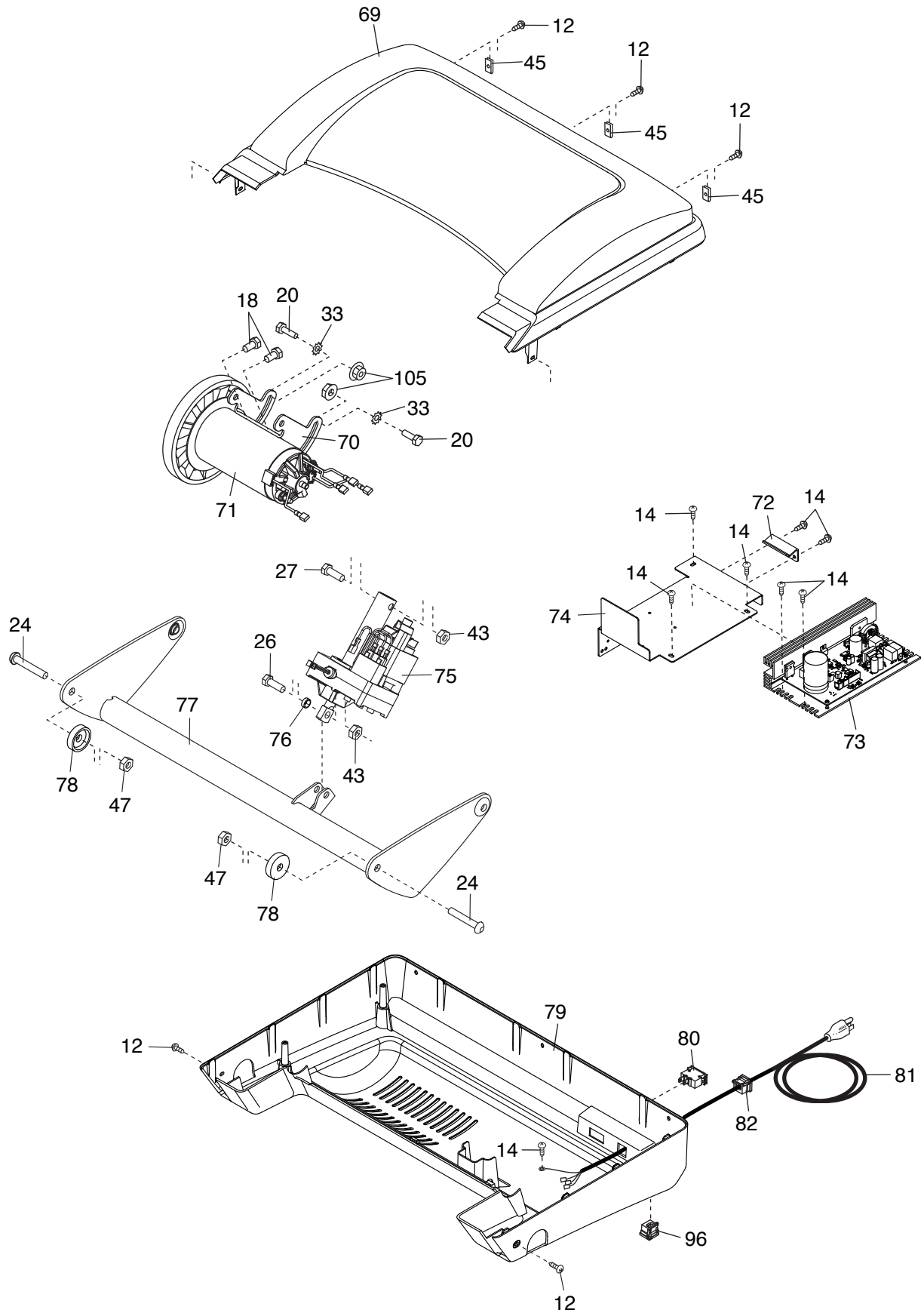

EXPLODED DRAWING C

Model No. GGTL39617.4 R0118A

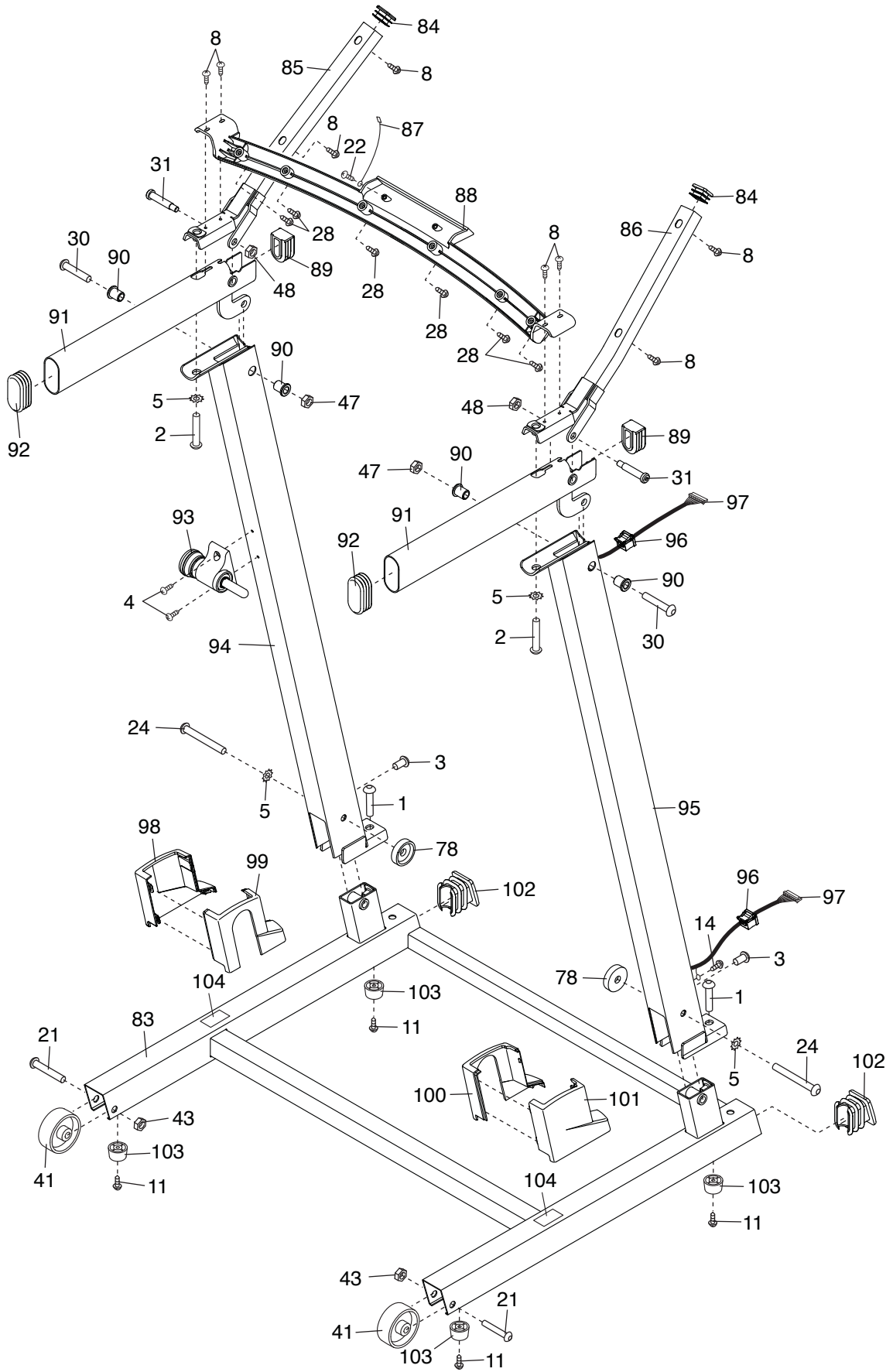

EXPLODED DRAWING D

Model No. GGTL39617.4 R0118A

