

# EXPLODED DRAWING A

Model No. GGTL39617.5 R0419A

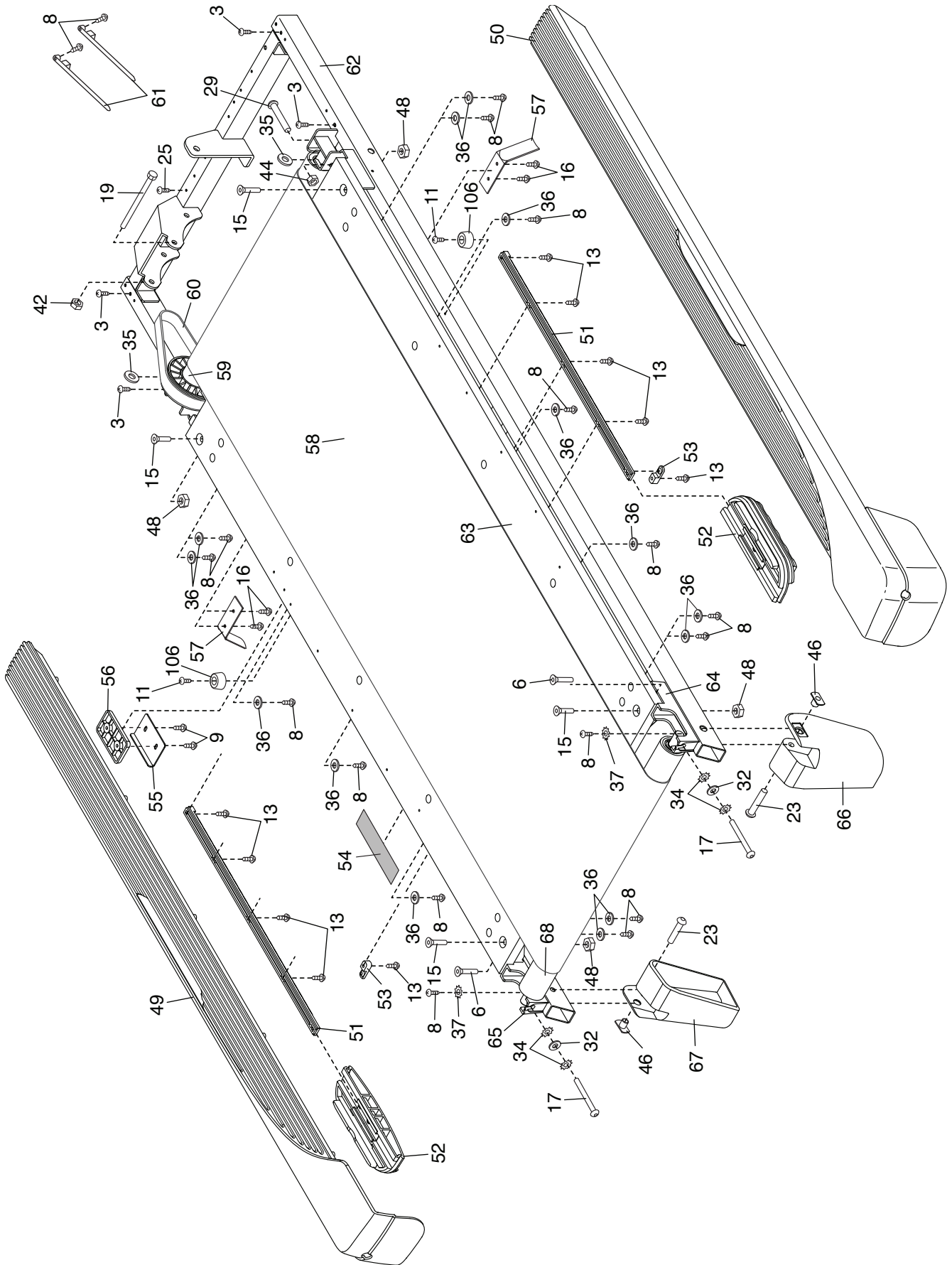

# EXPLODED DRAWING B

Model No. GGTL39617.5 R0419A

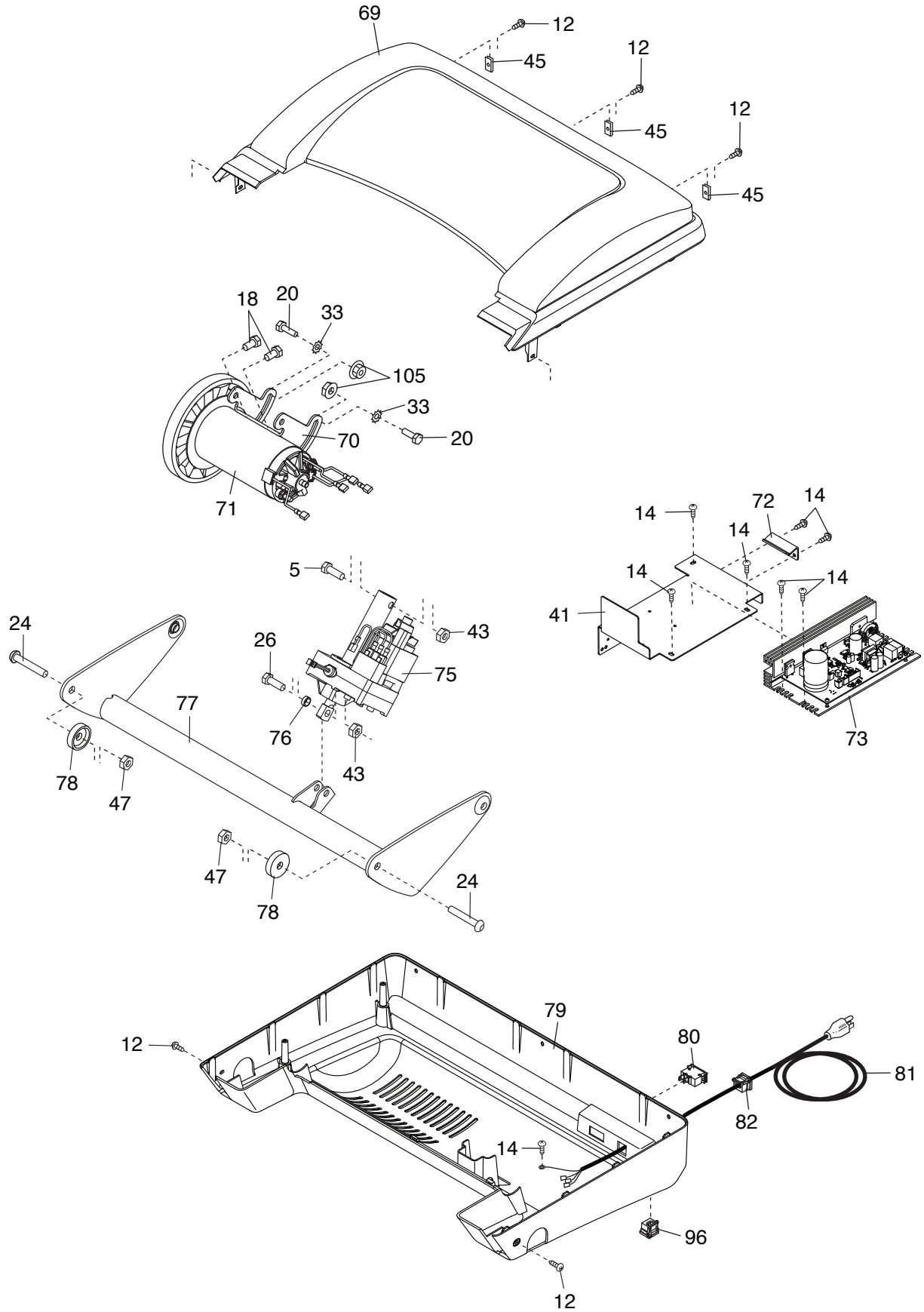

# EXPLODED DRAWING C

Model No. GGTL39617.5 R0419A

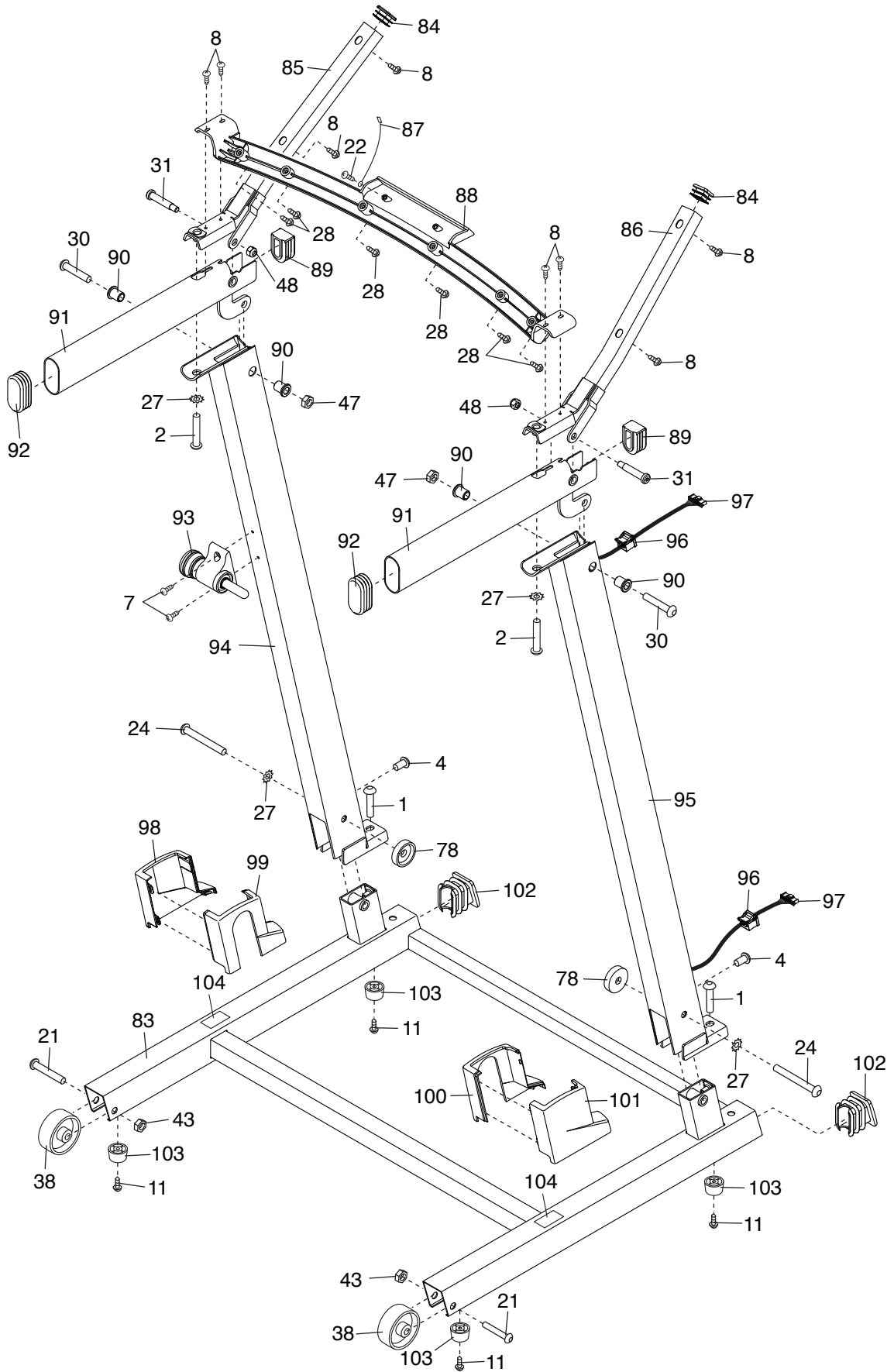

# EXPLODED DRAWING D

Model No. GGTL39617.5 R0419A

