

EXPLODED DRAWING A

Model No. GGTL40615.0 R1015A

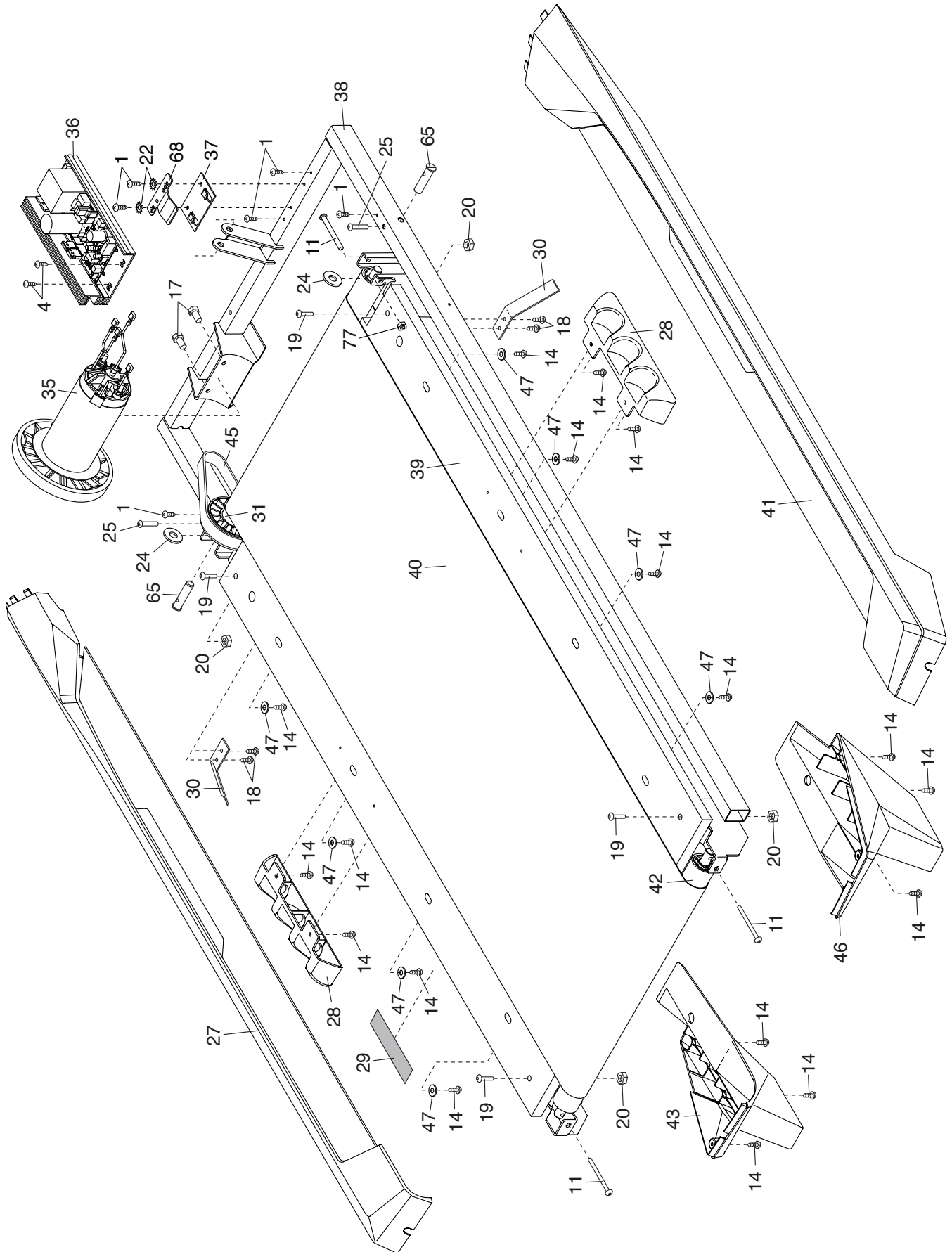

EXPLODED DRAWING B

Model No. GGTL40615.0 R1015A

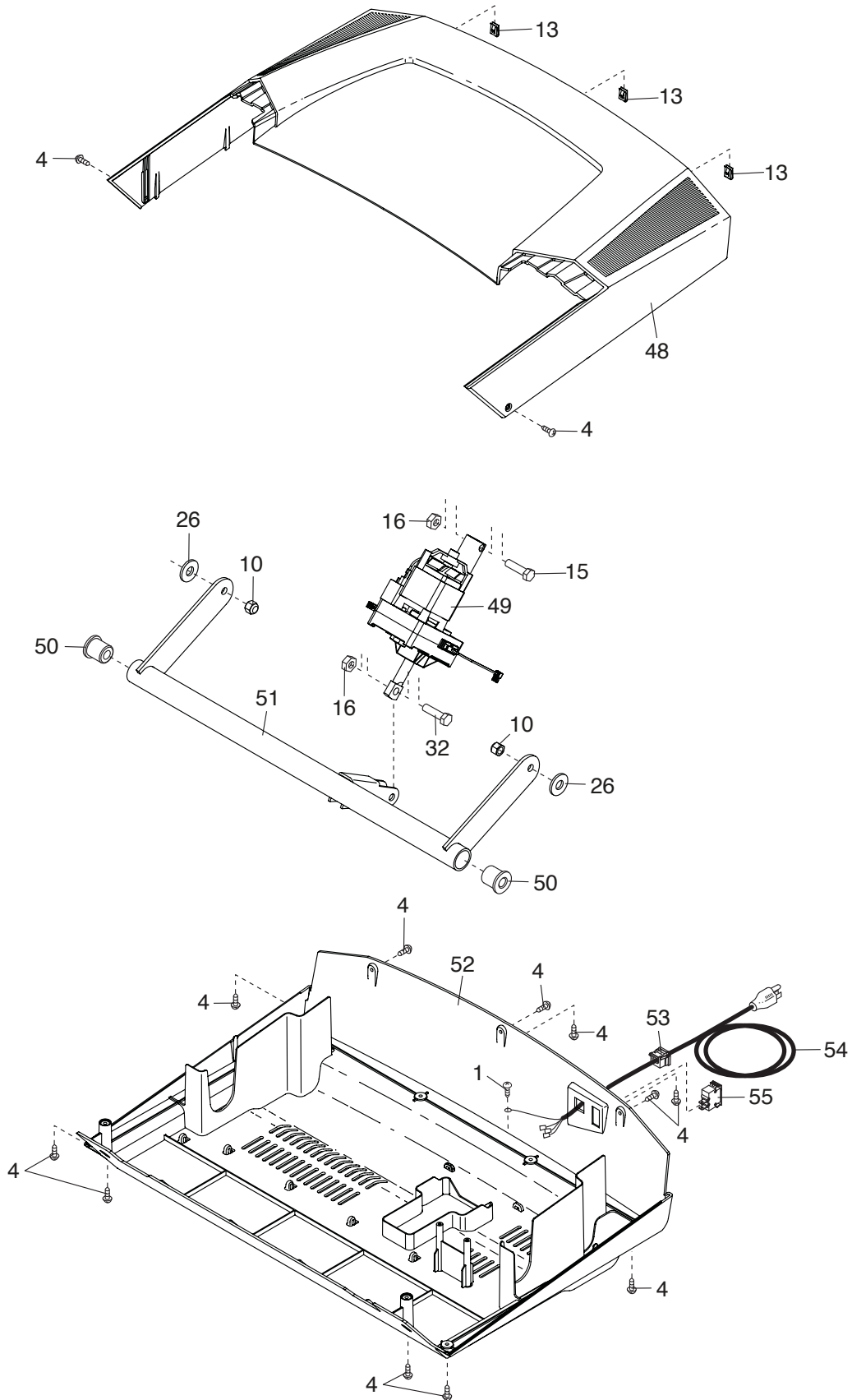

EXPLODED DRAWING C

Model No. GGTL40615.0 R1015A

