

# EXPLODED DRAWING A—Model No. GGTL59606.0

R0307A

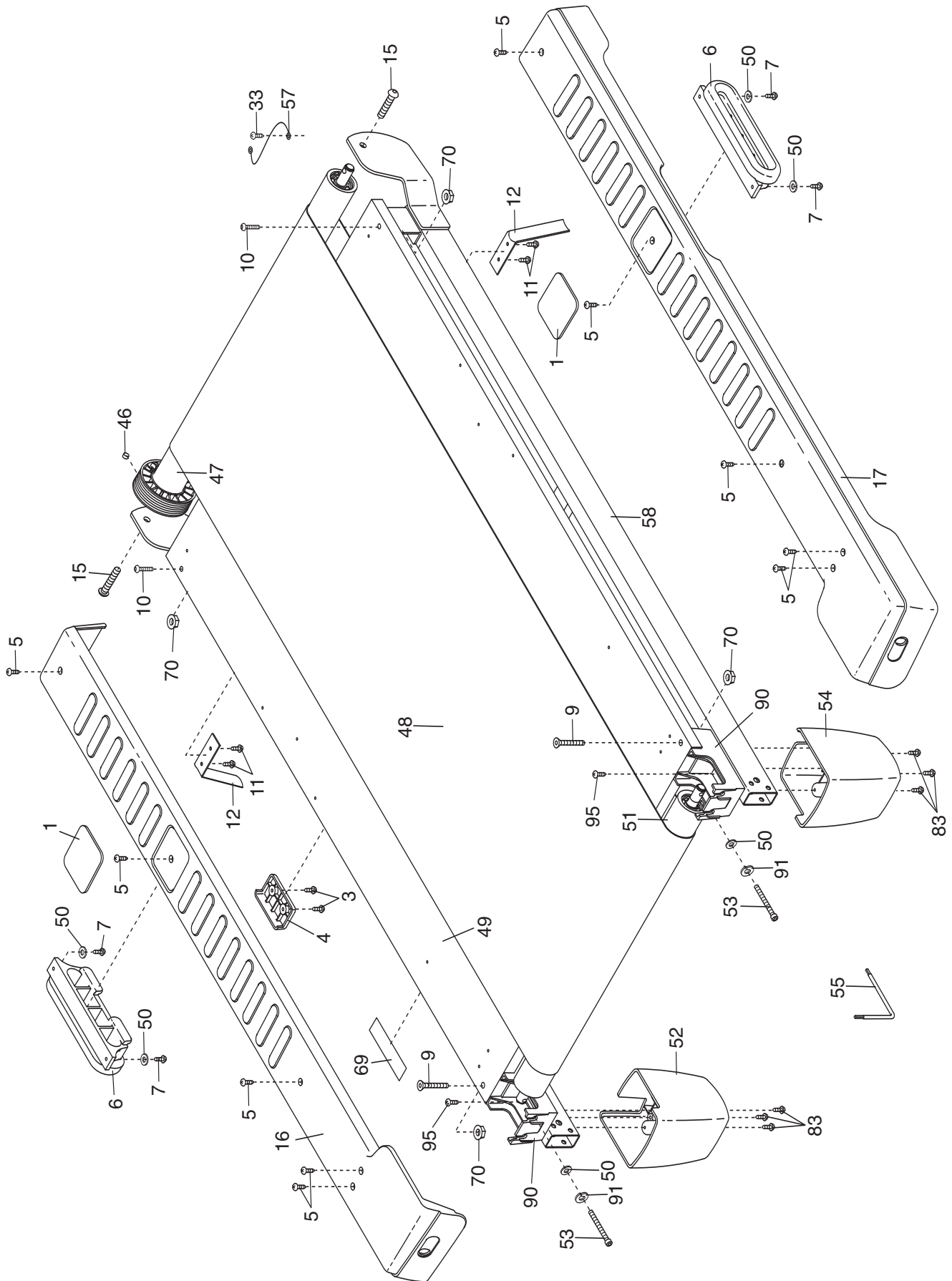

# EXPLODED DRAWING B—Model No. GGTL59606.0

R0307A

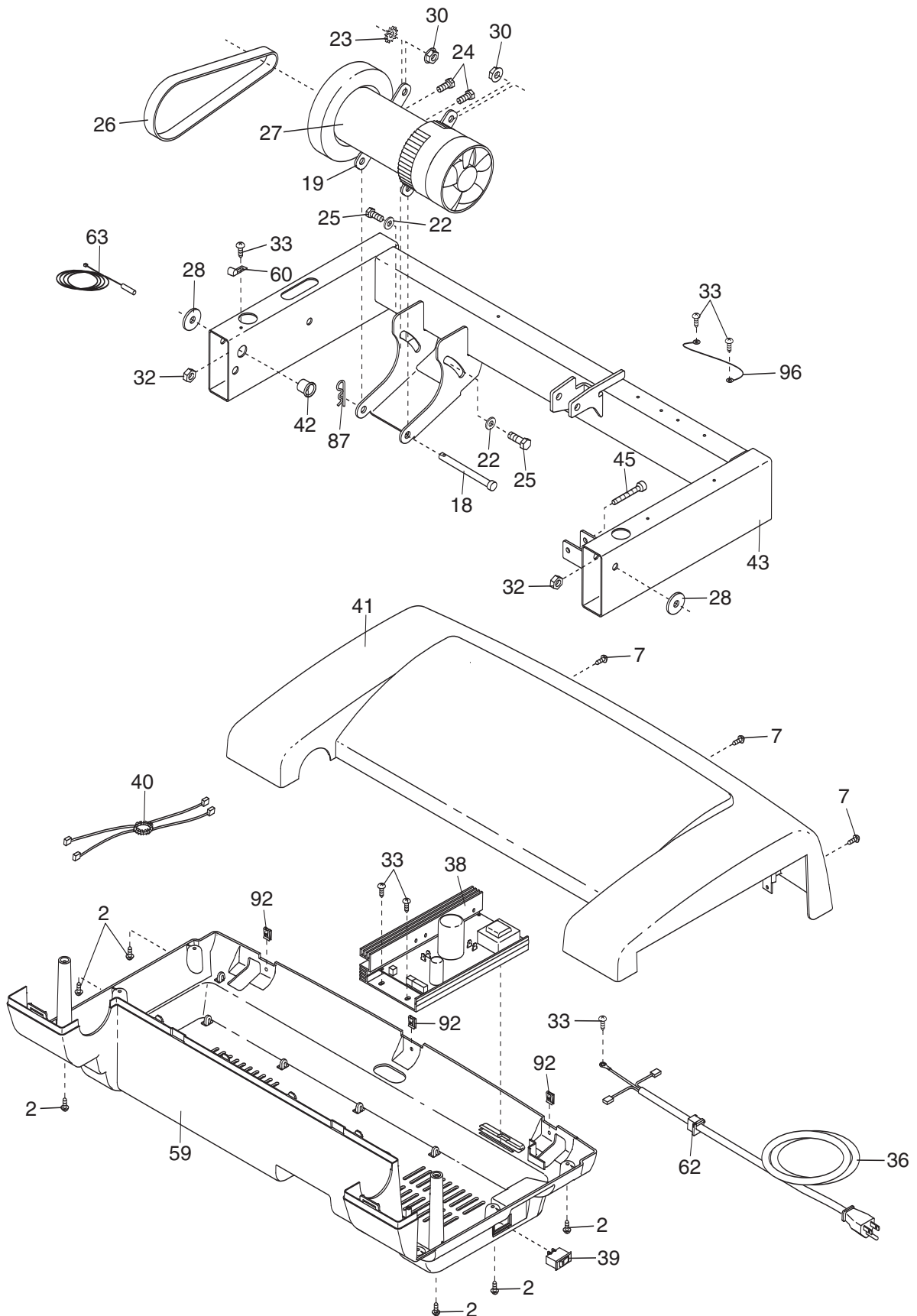

# EXPLODED DRAWING C—Model No. GGTL59606.0

R0307A

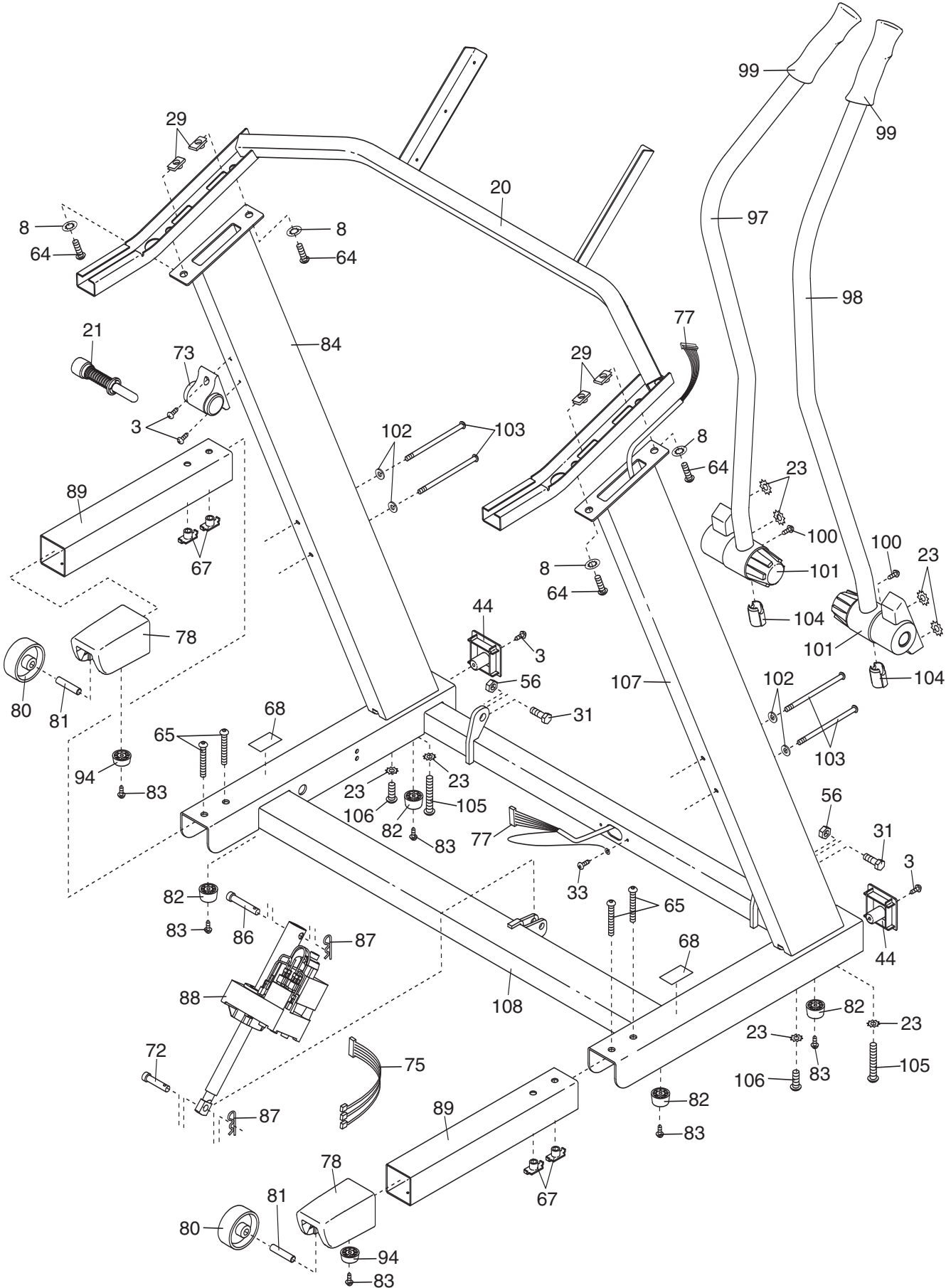

# EXPLODED DRAWING D—Model No. GGTL59606.0

R0307A

