

# EXPLODED DRAWING A

Model No. GGTL59613.1 R0715A

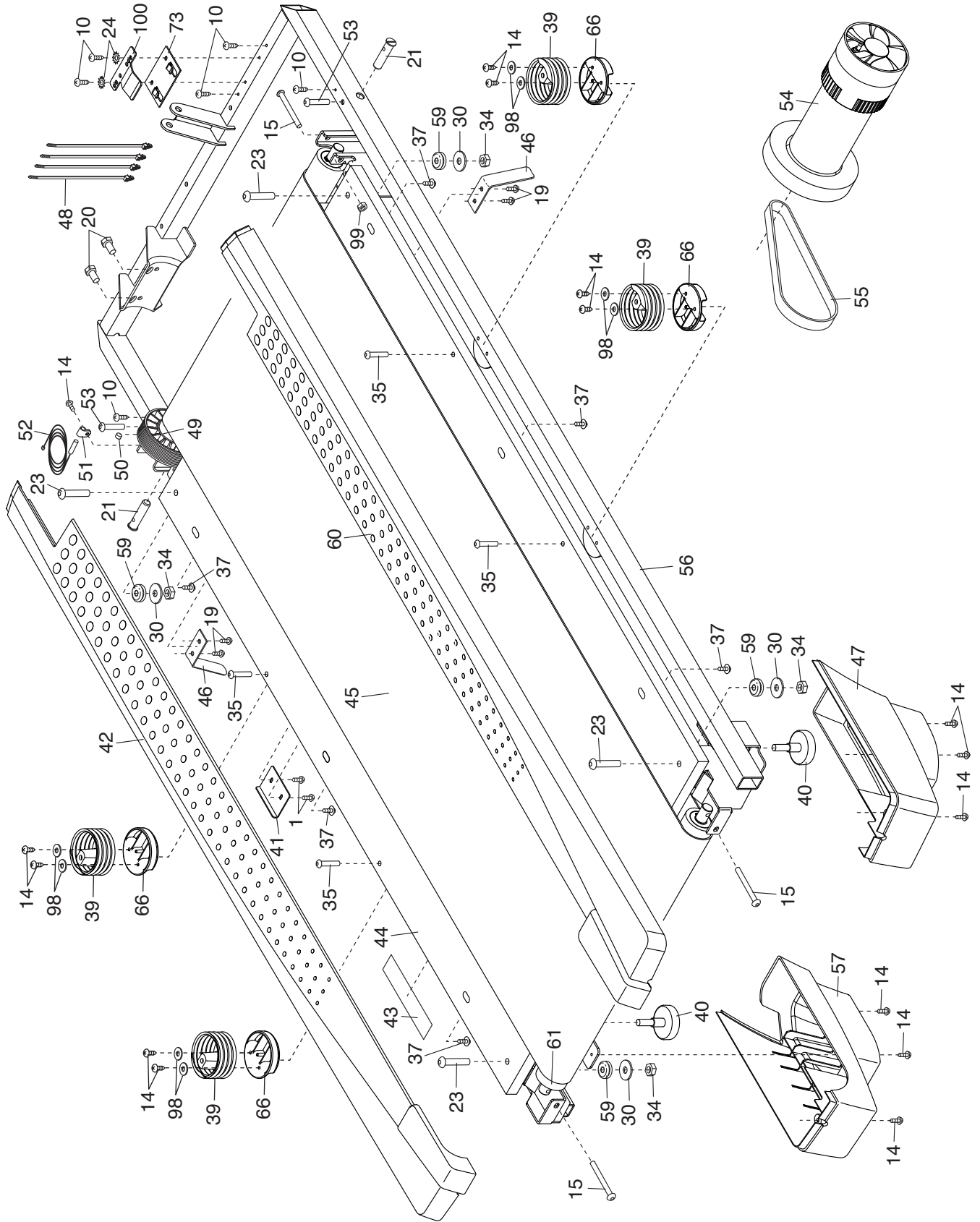

# EXPLODED DRAWING B

Model No. GGTL59613.1 R0715A

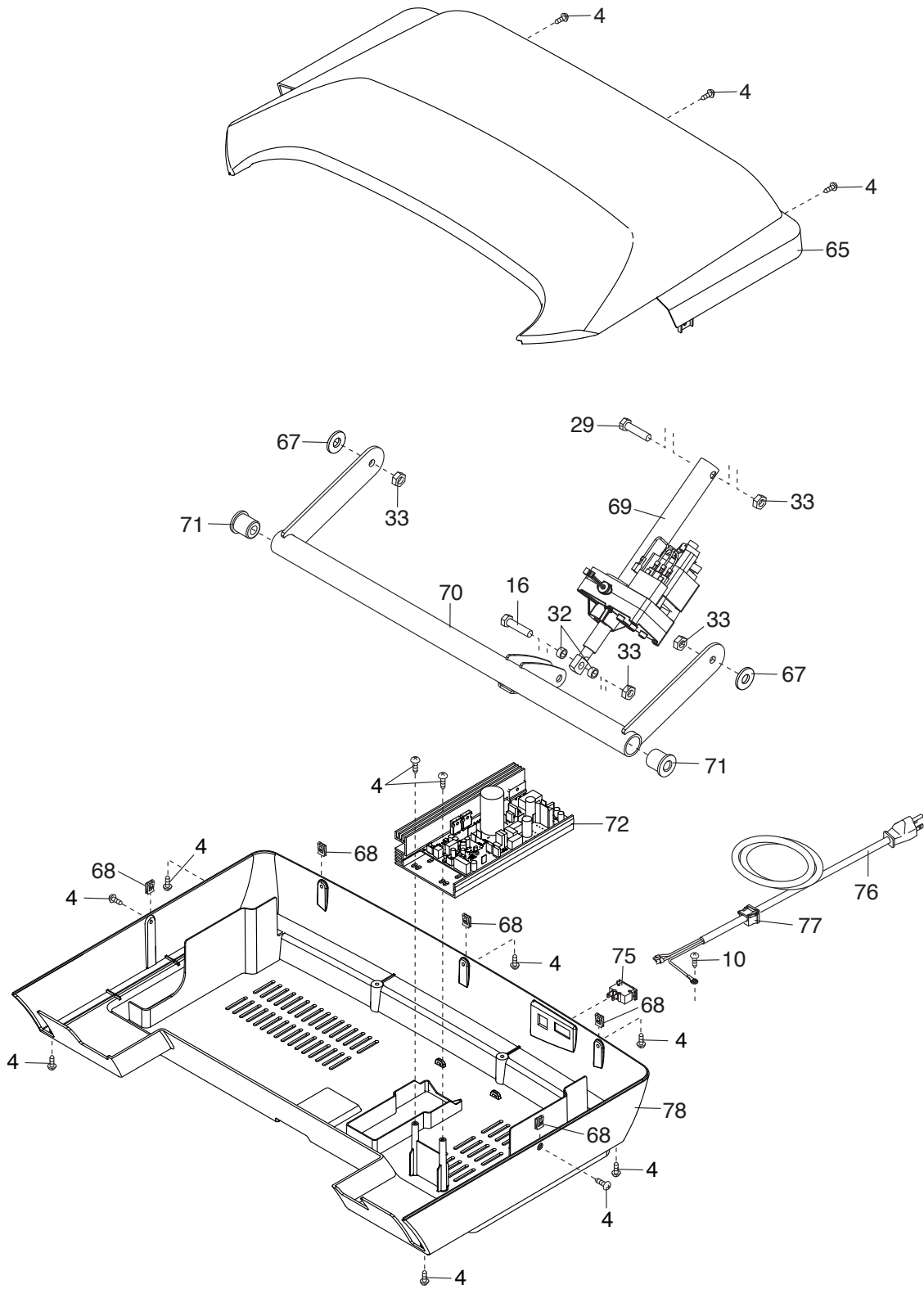

# EXPLODED DRAWING C

Model No. GGTL59613.1 R0715A

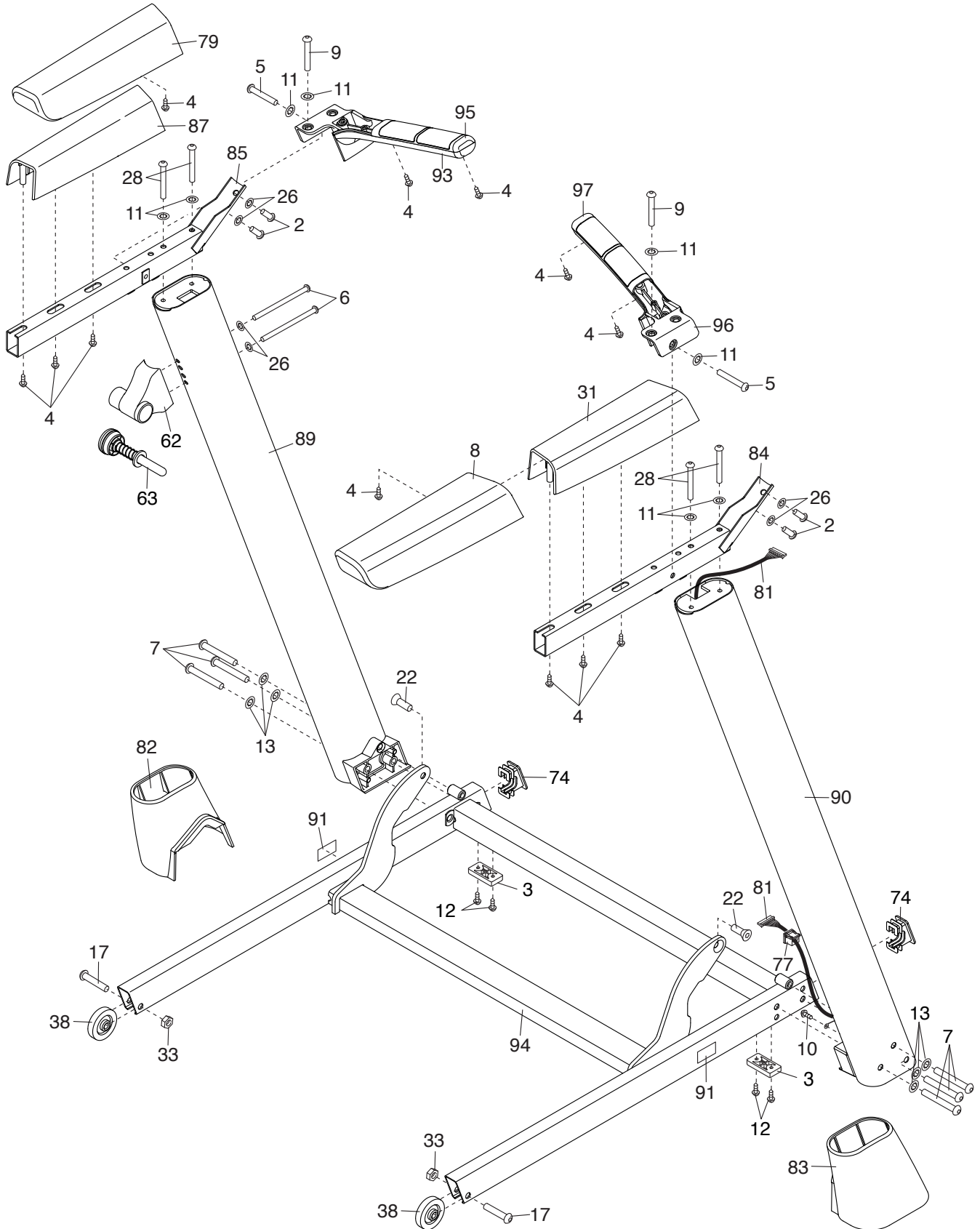

# EXPLODED DRAWING D

Model No. GGTL59613.1 R0715A

