

EXPLODED DRAWING A

Model No. GGTL59613.0 R1113A

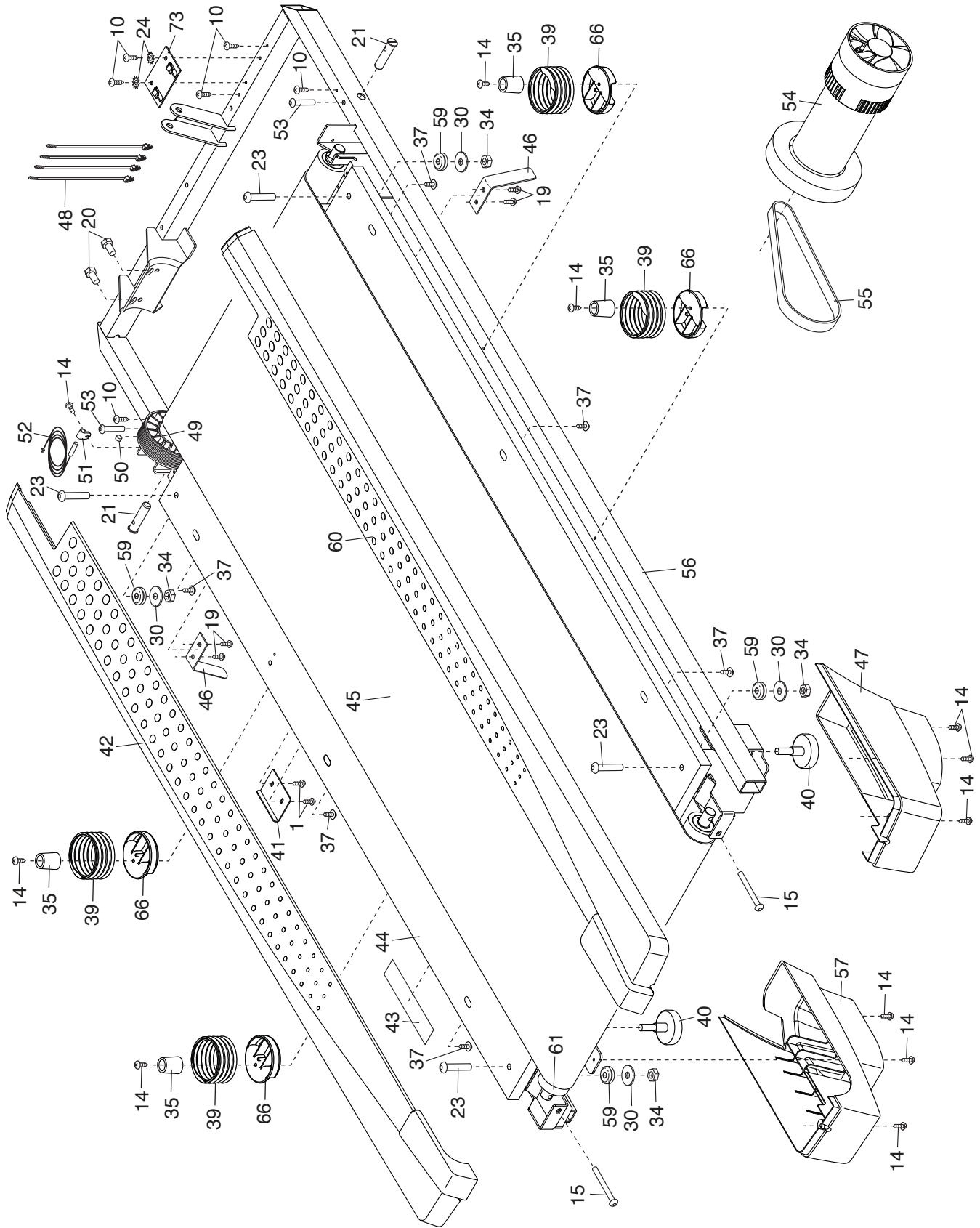

EXPLODED DRAWING B

Model No. GGTL59613.0 R1113A

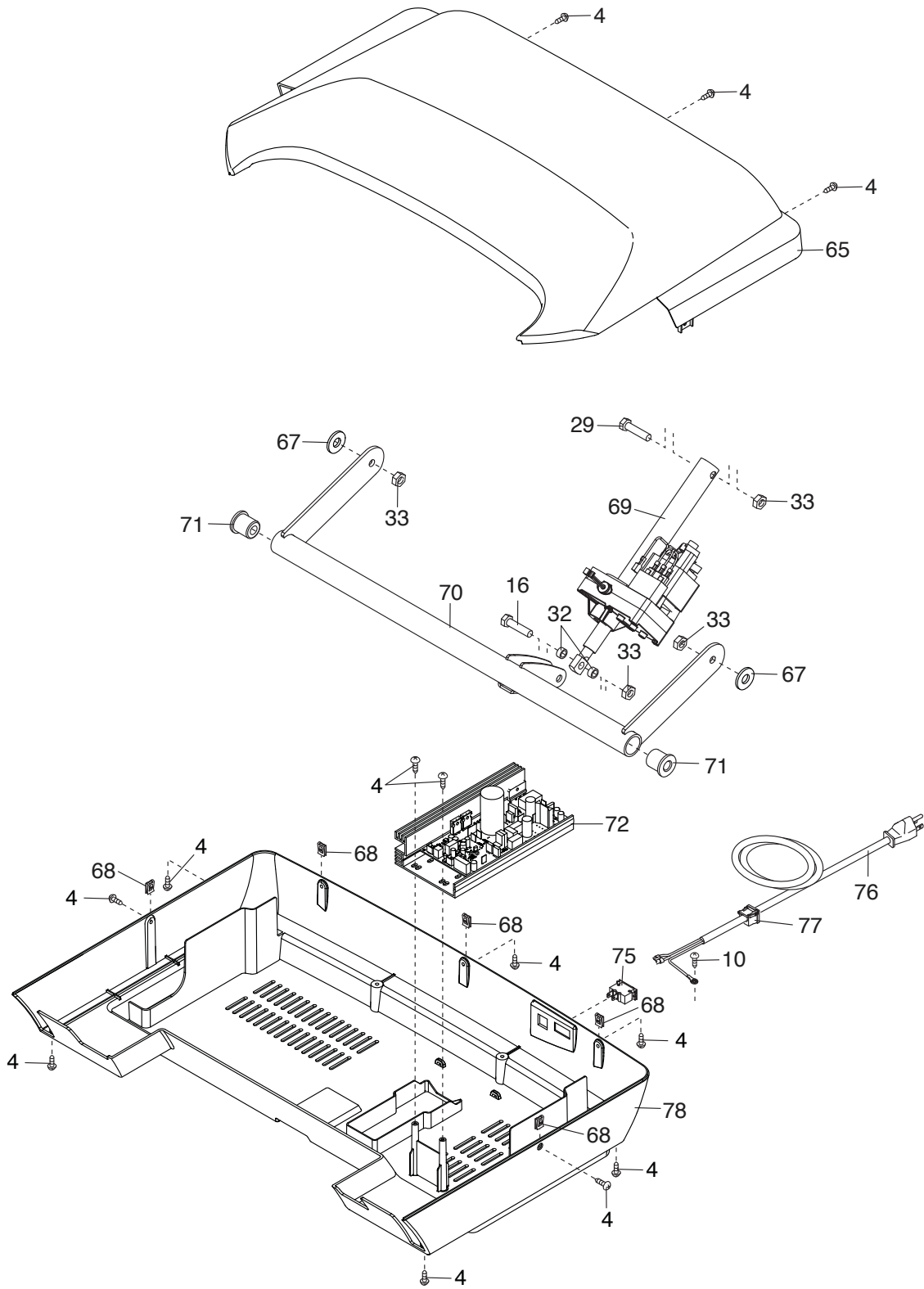

EXPLODED DRAWING C

Model No. GGTL59613.0 R1113A

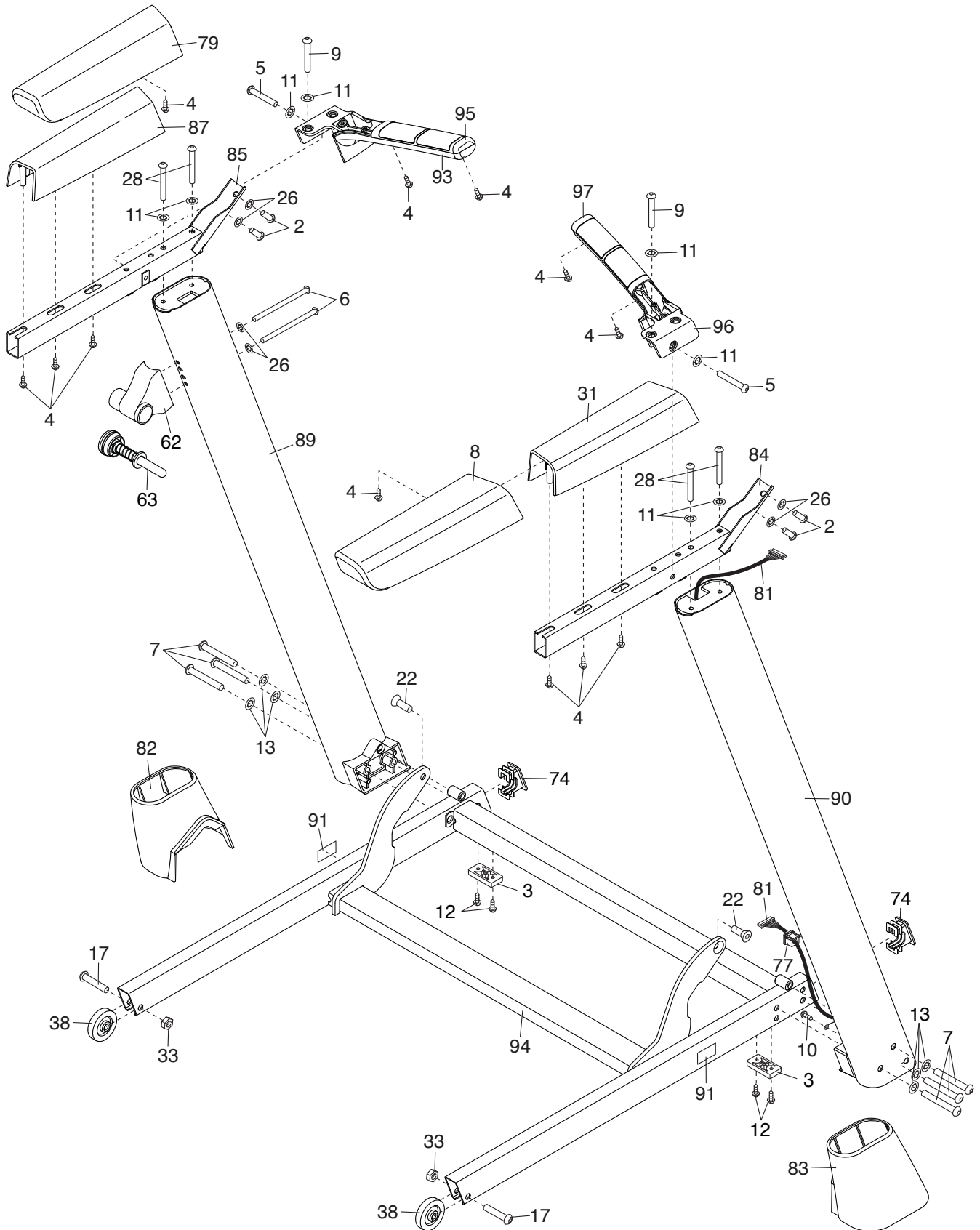

EXPLODED DRAWING D

Model No. GGTL59613.0 R1113A

