

# EXPLODED DRAWING A

Model No. HRTL61510.0 R0411A

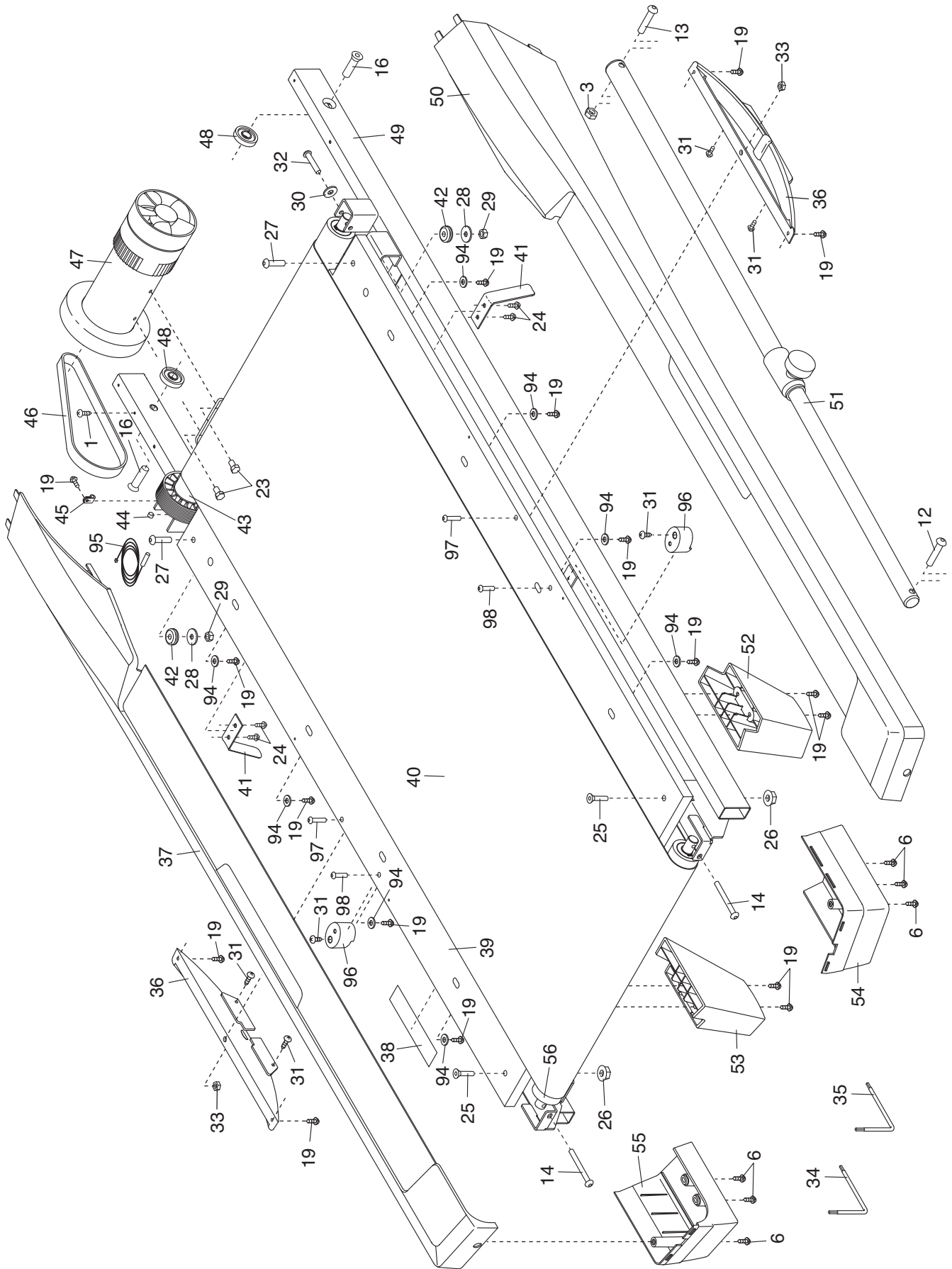

# EXPLODED DRAWING B

Model No. HRTL61510.0 R0411A

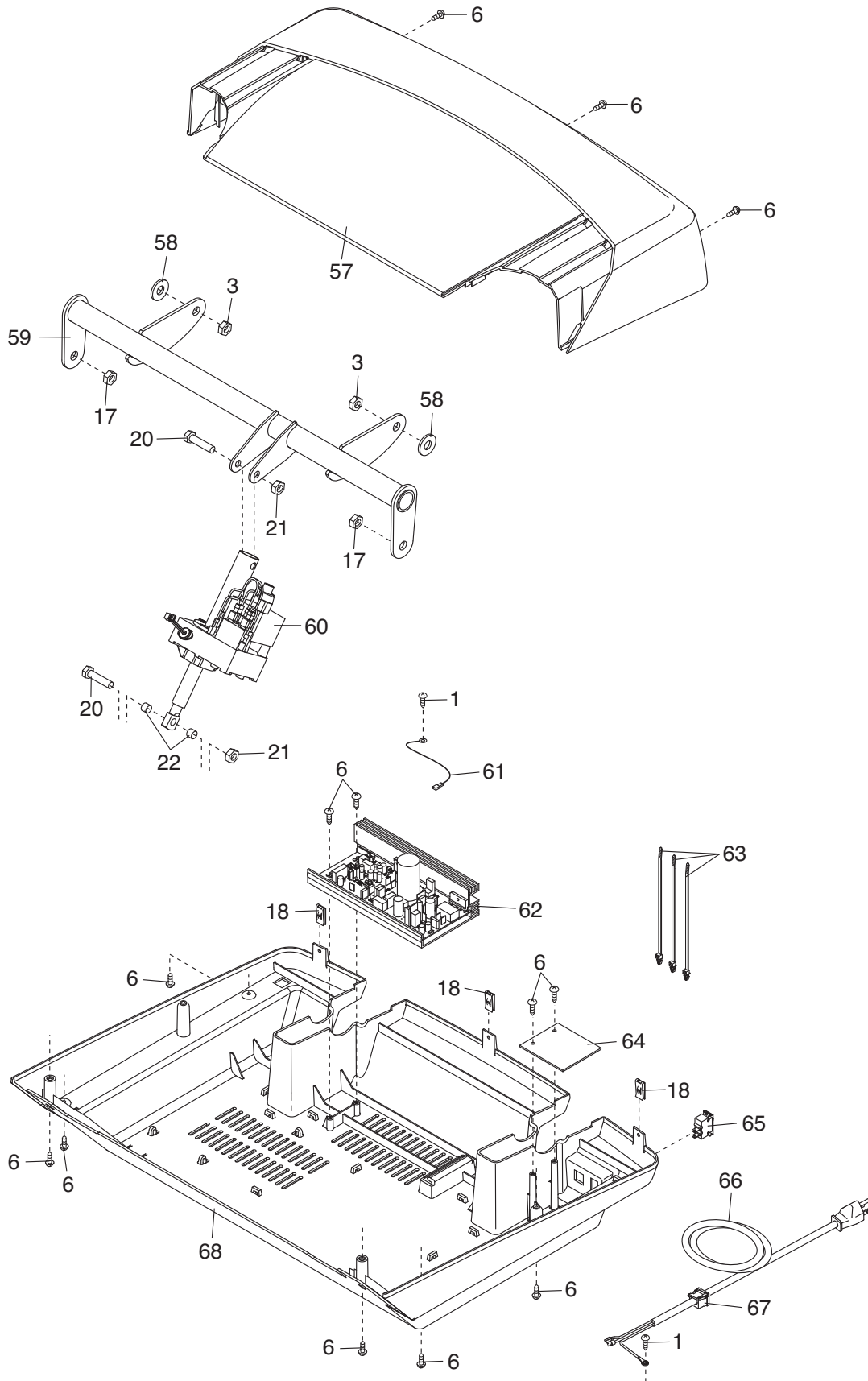

# EXPLODED DRAWING C

Model No. HRTL61510.0 R0411A

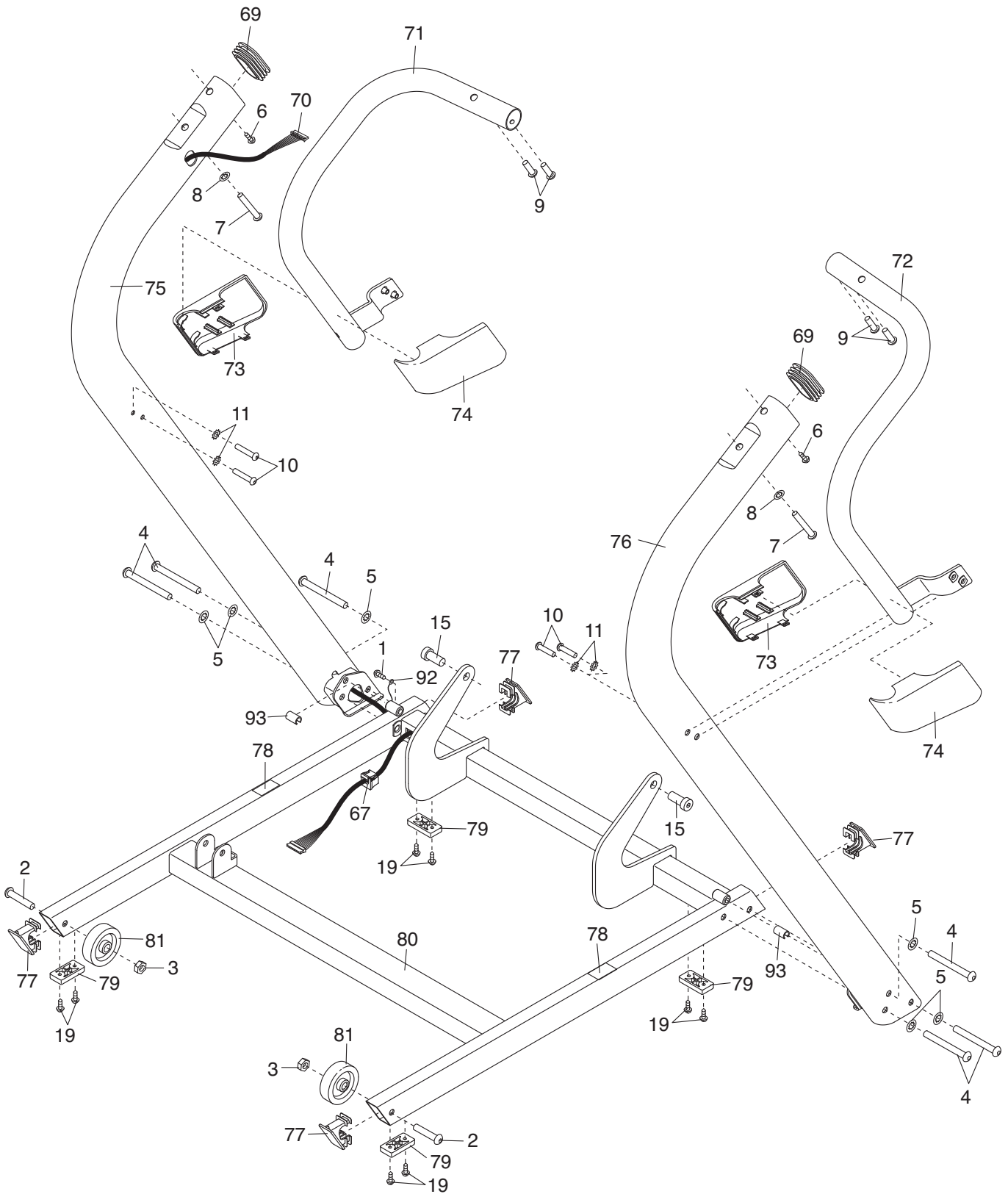

# EXPLODED DRAWING D

Model No. HRTL61510.0 R0411A

