

EXPLODED DRAWING A

Model No. HRTL70014C.0 R0815A

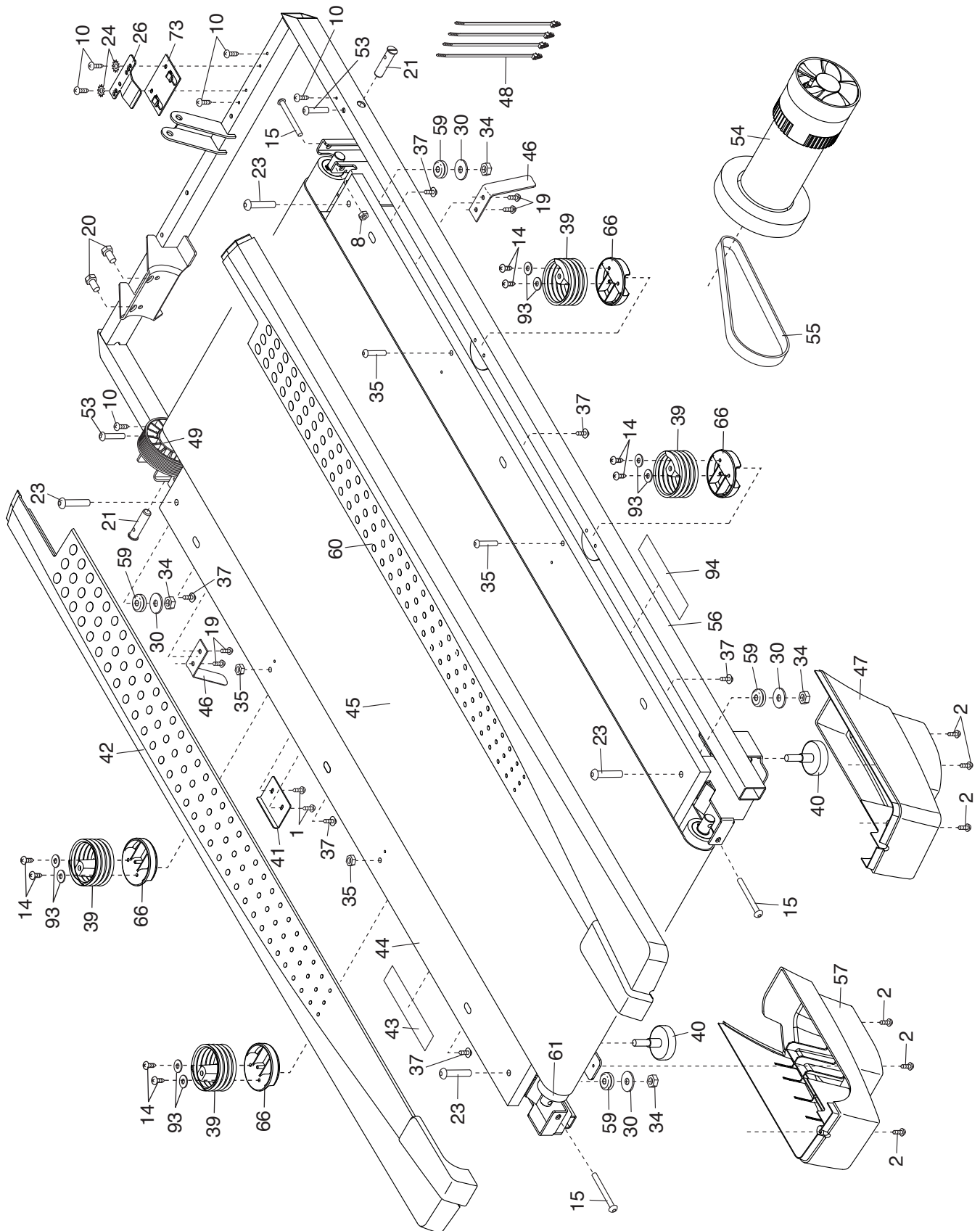

EXPLODED DRAWING B

Model No. HRTL70014C.0 R0815A

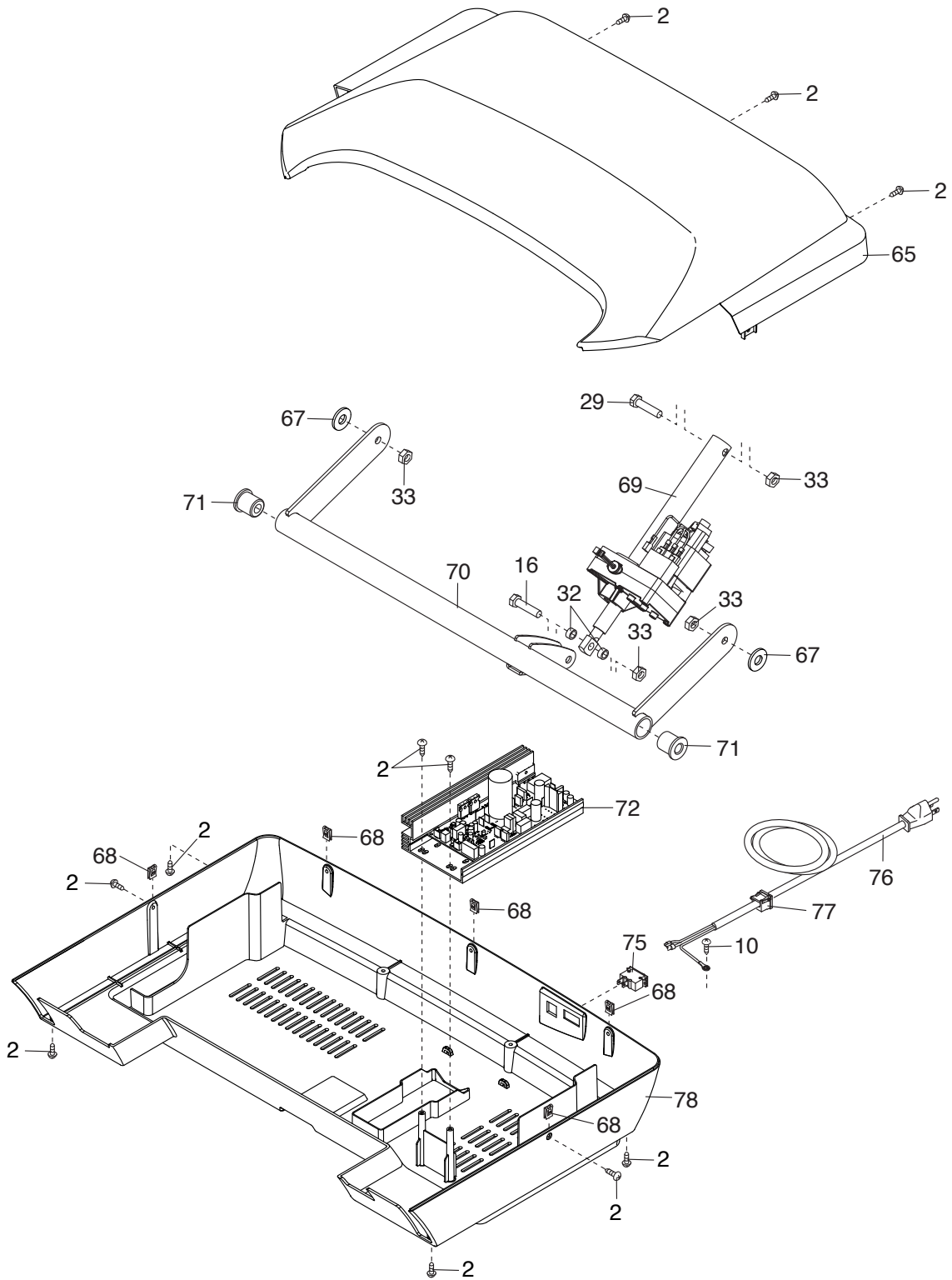

EXPLODED DRAWING C

Model No. HRTL70014C.0 R0815A

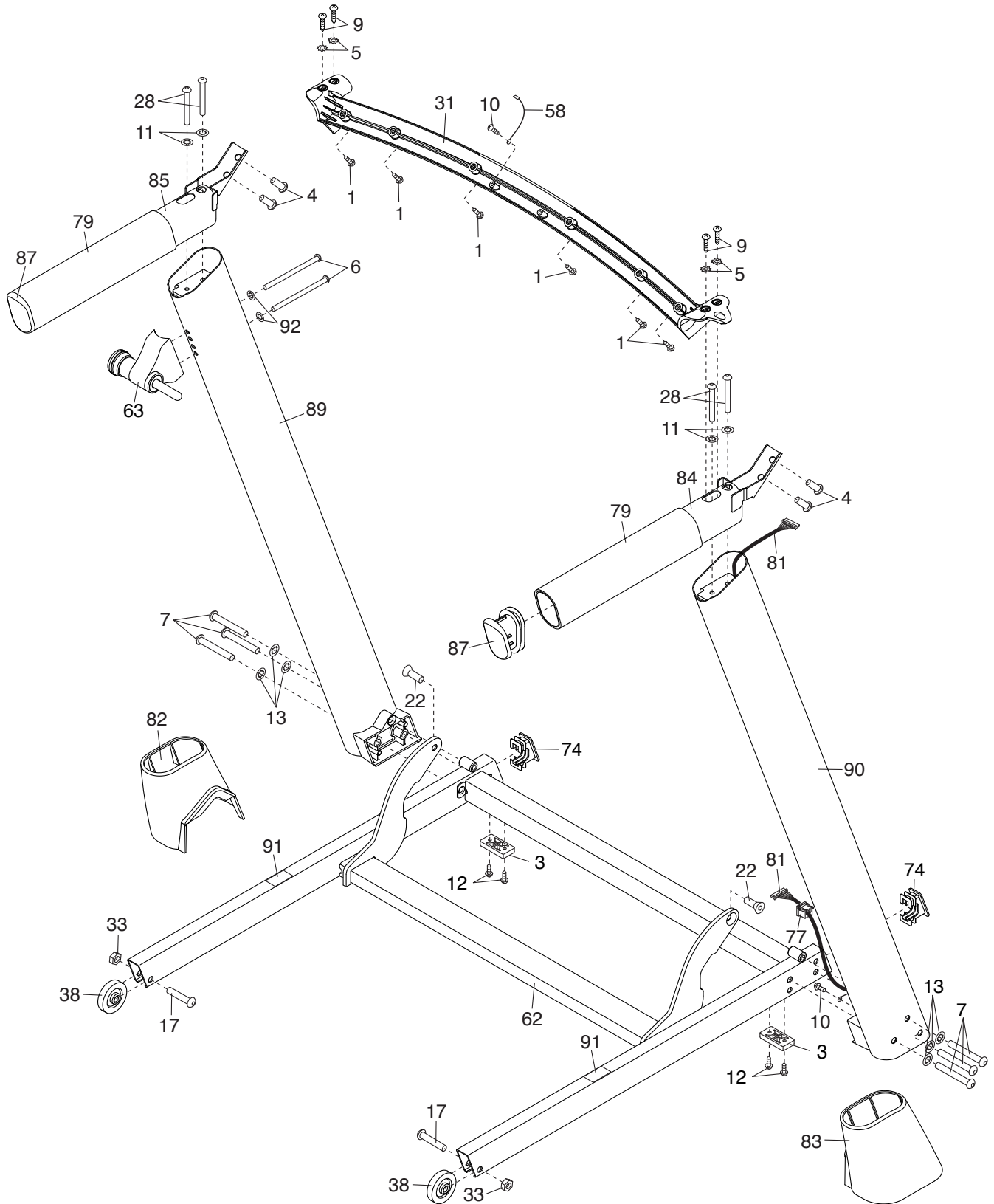

EXPLODED DRAWING D

Model No. HRTL70014C.0 R0815A

