

EXPLODED DRAWING A—Model No. HRTL71706.1

R0108A

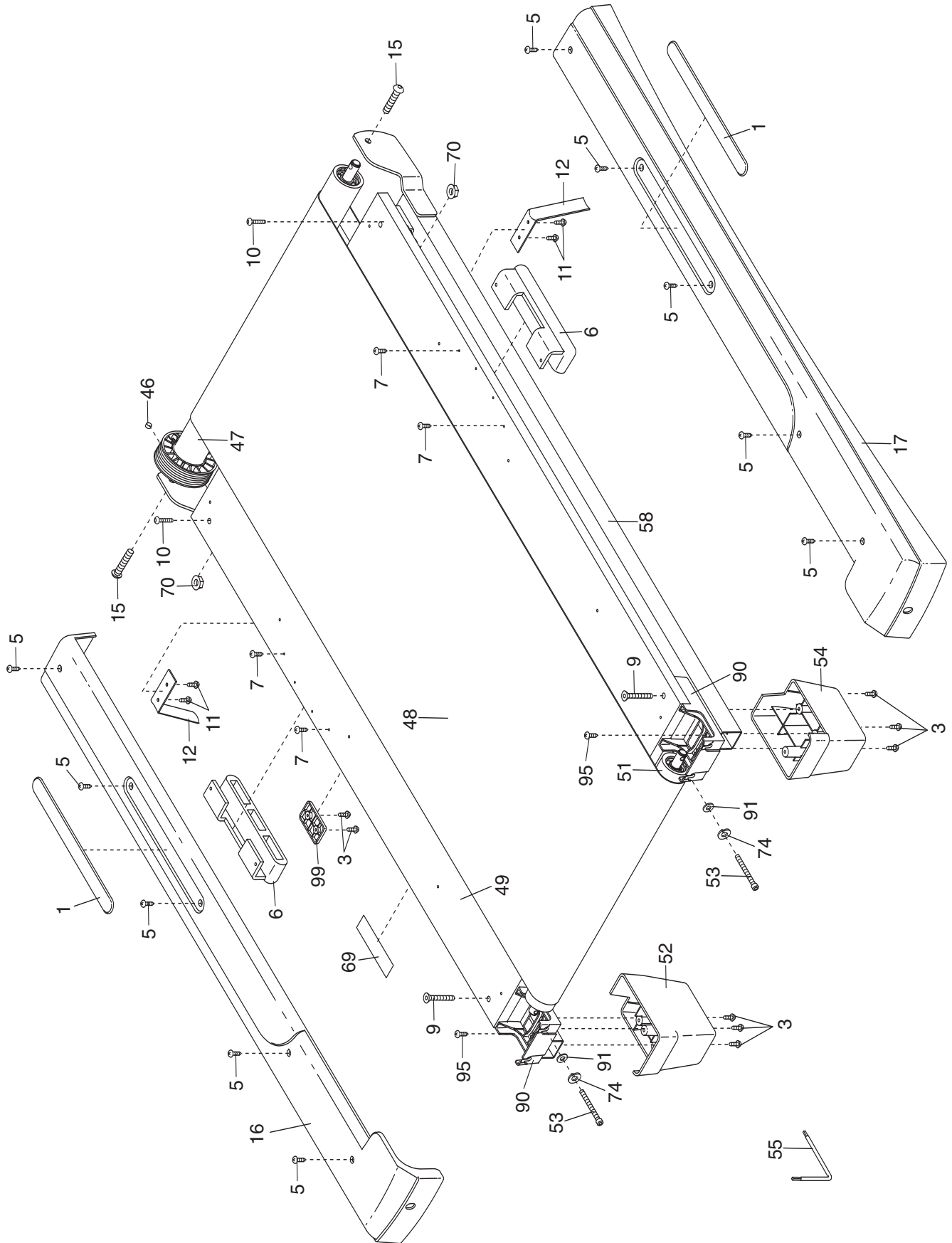

EXPLODED DRAWING B—Model No. HRTL71706.1

R0108A

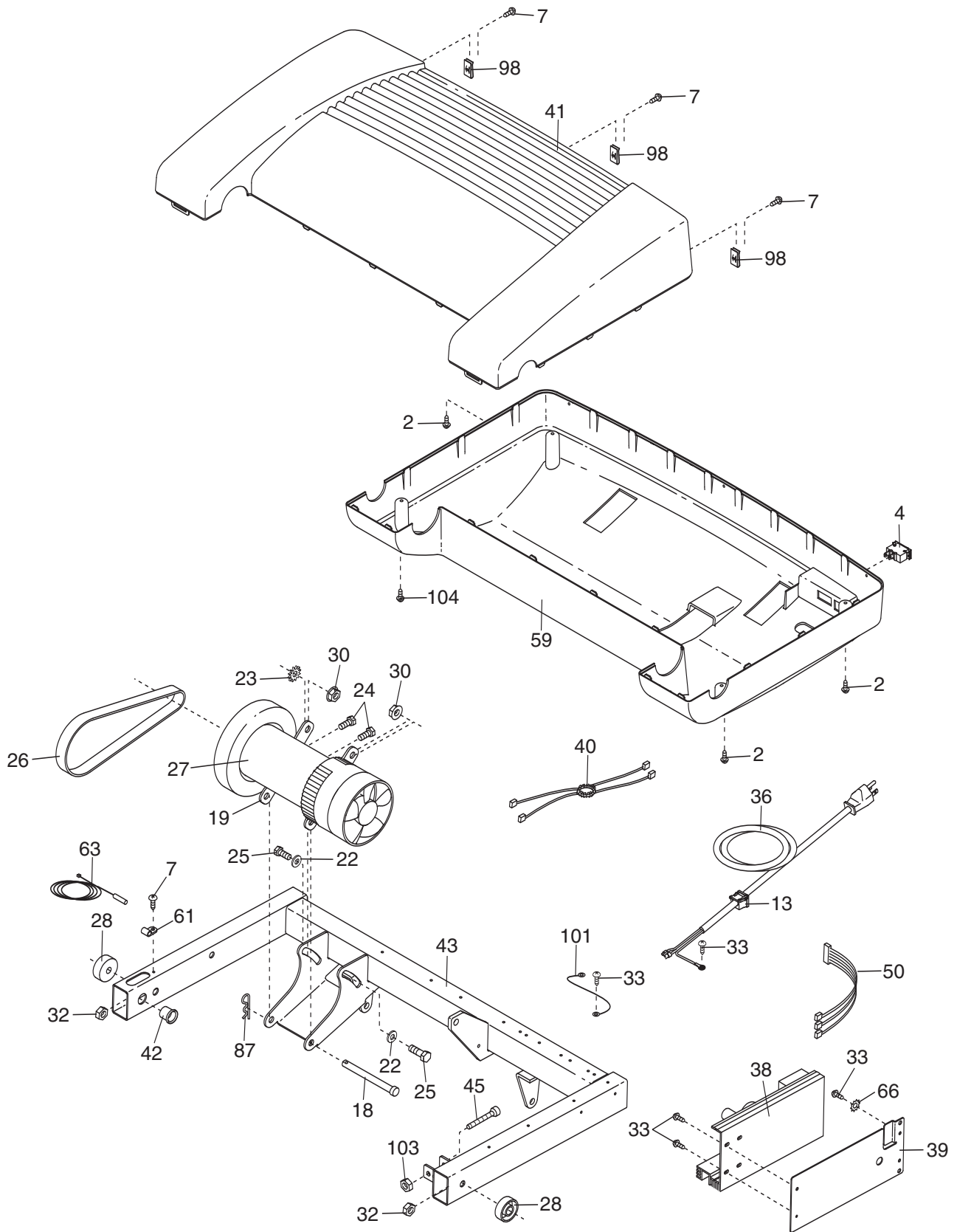

EXPLODED DRAWING C—Model No. HRTL71706.1

R0108A

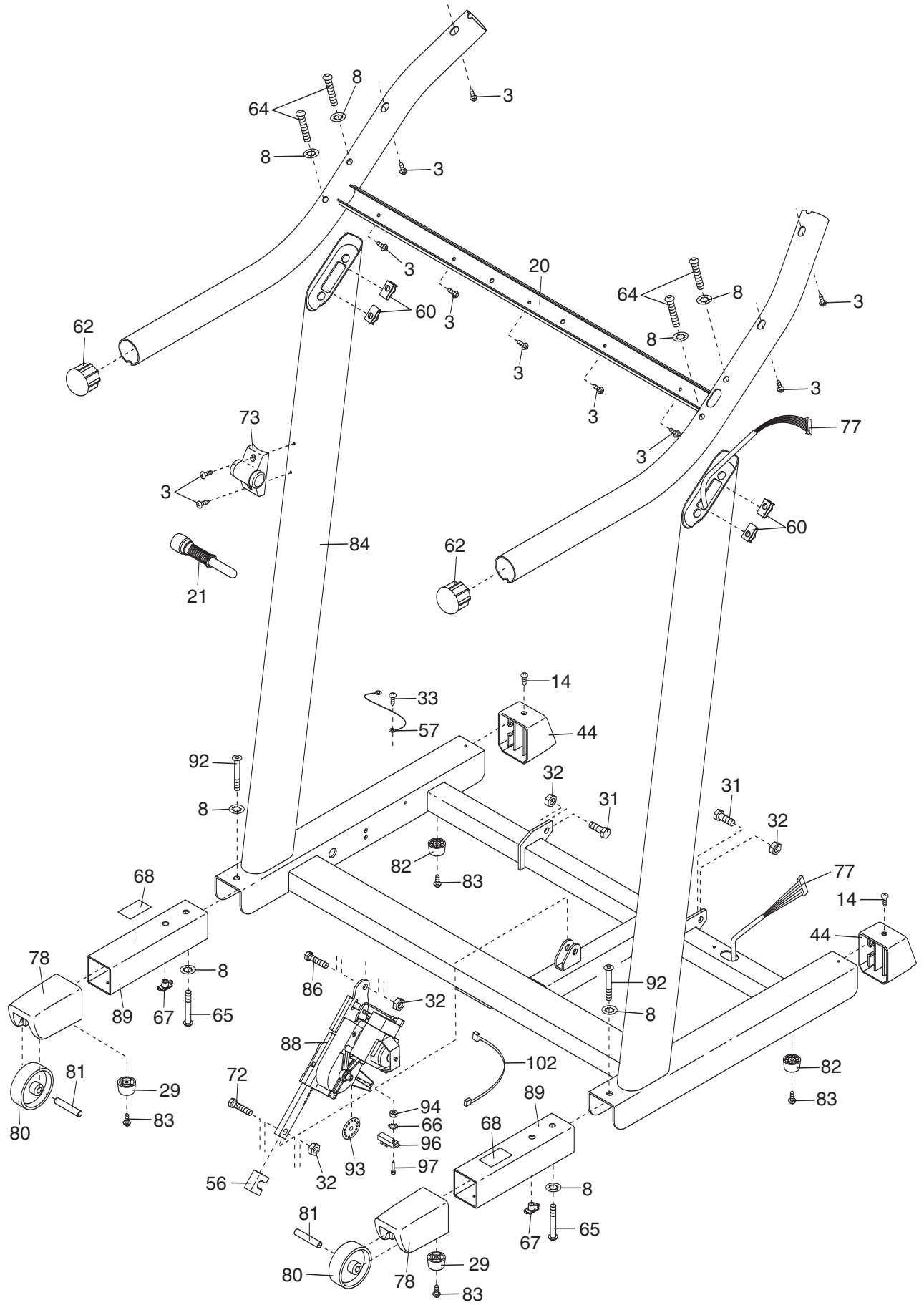

EXPLODED DRAWING D—Model No. HRTL71706.1

R0108A

