

EXPLODED DRAWING A

Model No. HRTL80510.2 R0211A

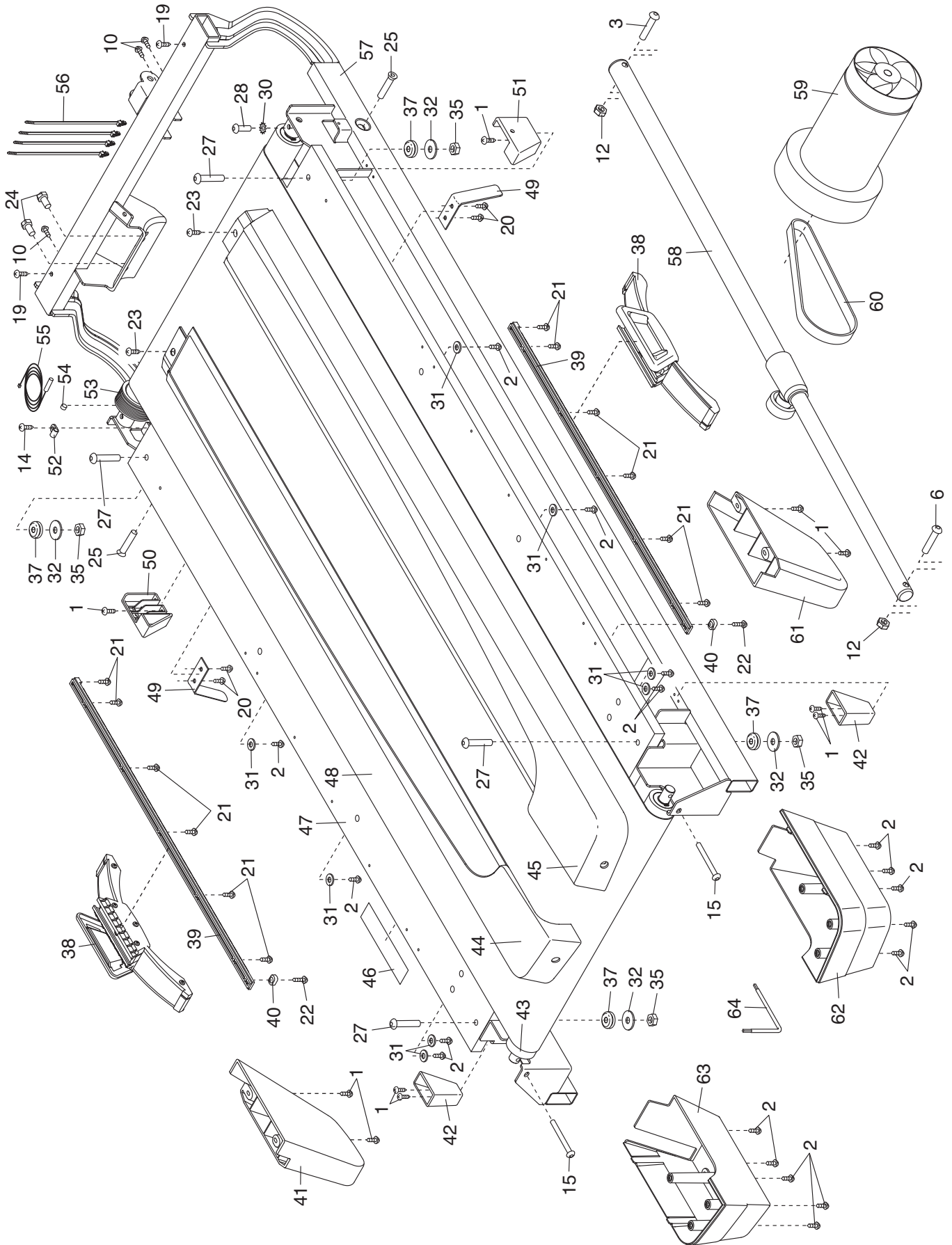

EXPLODED DRAWING B

Model No. HRTL80510.2 R0211A

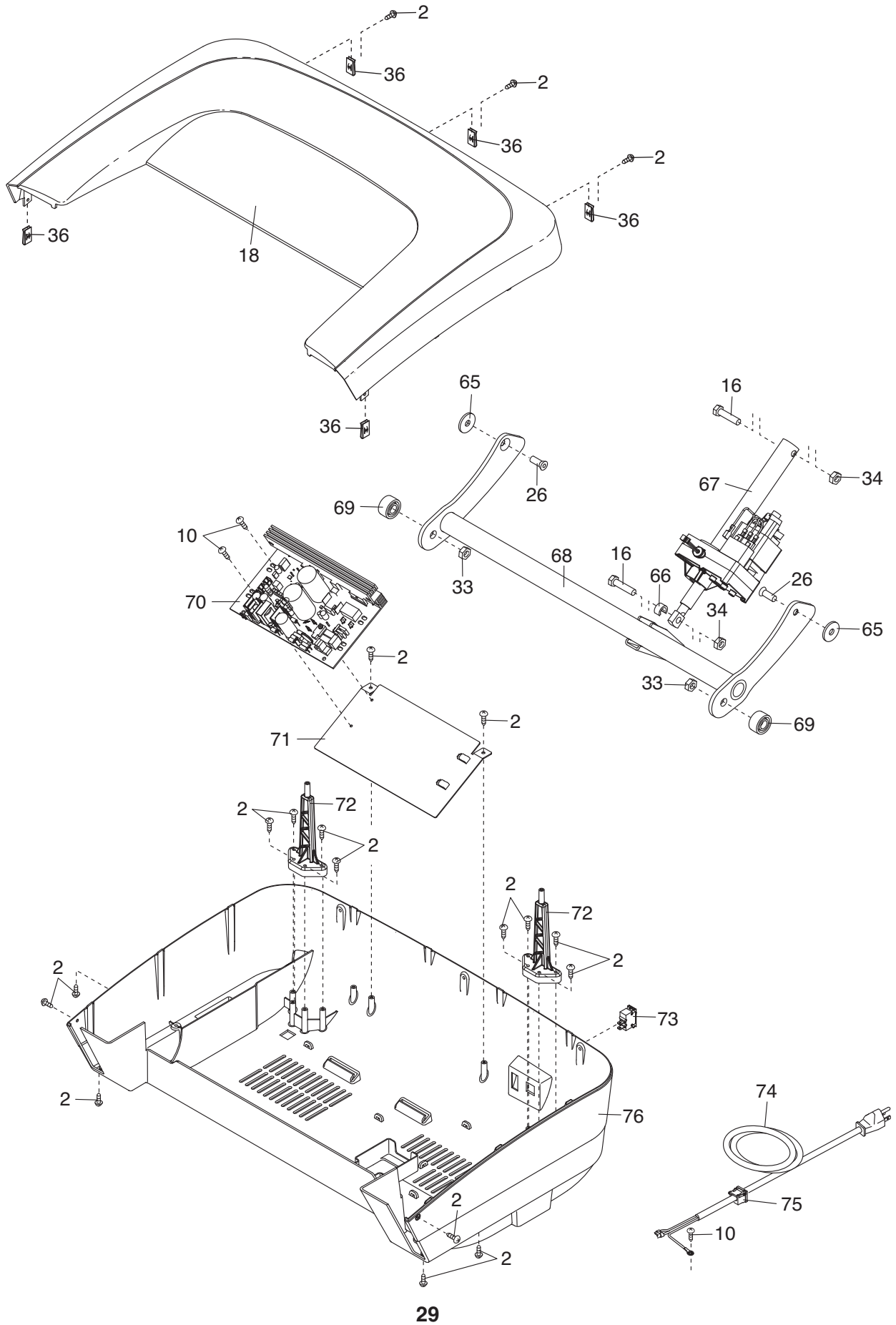

EXPLODED DRAWING D

Model No. HRTL80510.2 R0211A

