

EXPLODED DRAWING—Model No. NCTL15990

R0801A

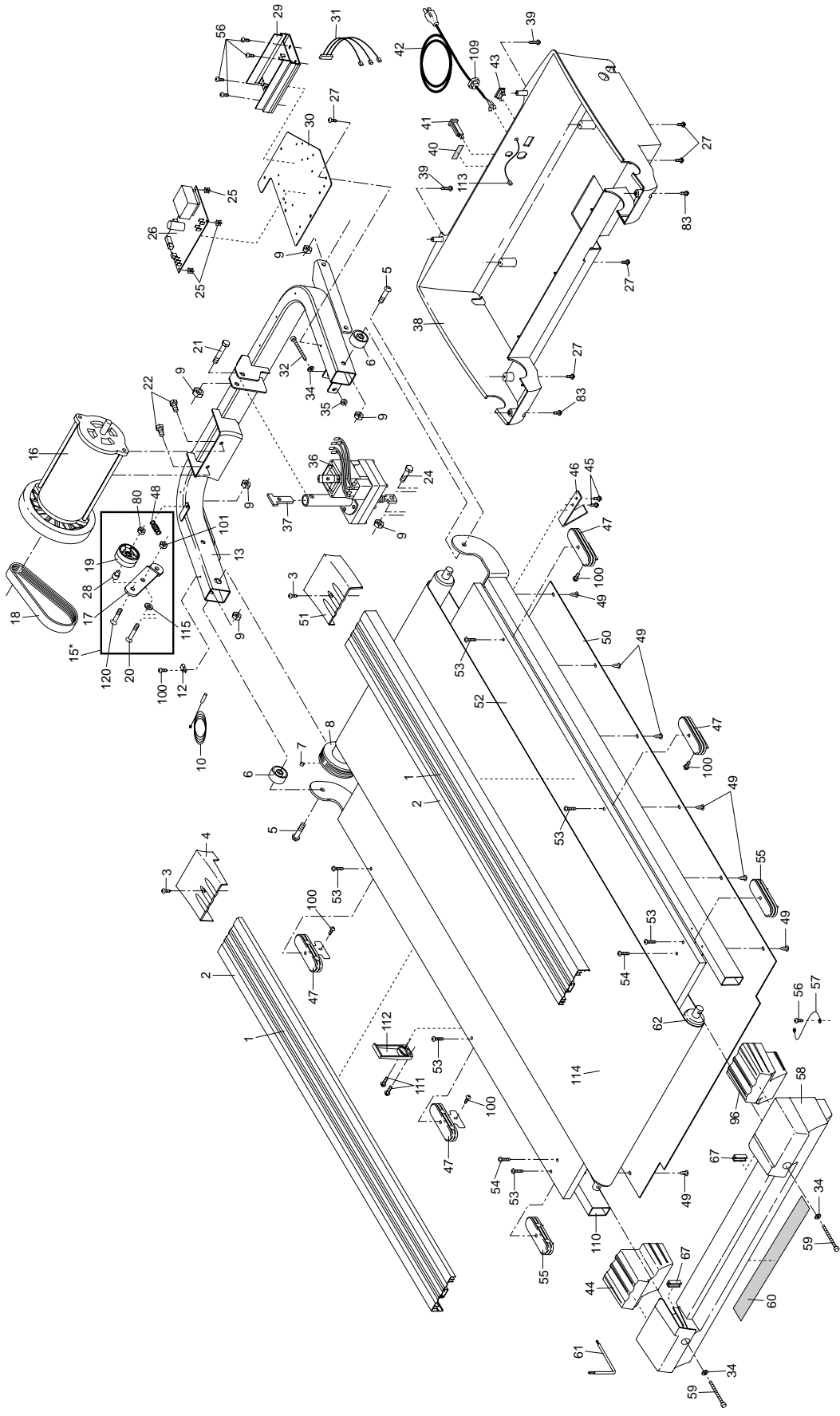

To identify the parts shown on this exploded drawing, refer to the PART LIST on pages 30 and 31 of the USER'S MANUAL.

EXPLODED DRAWING—Model No. NCTL15990

R0801A

