

EXPLODED DRAWING—Model No. NCTL15991

R0702A

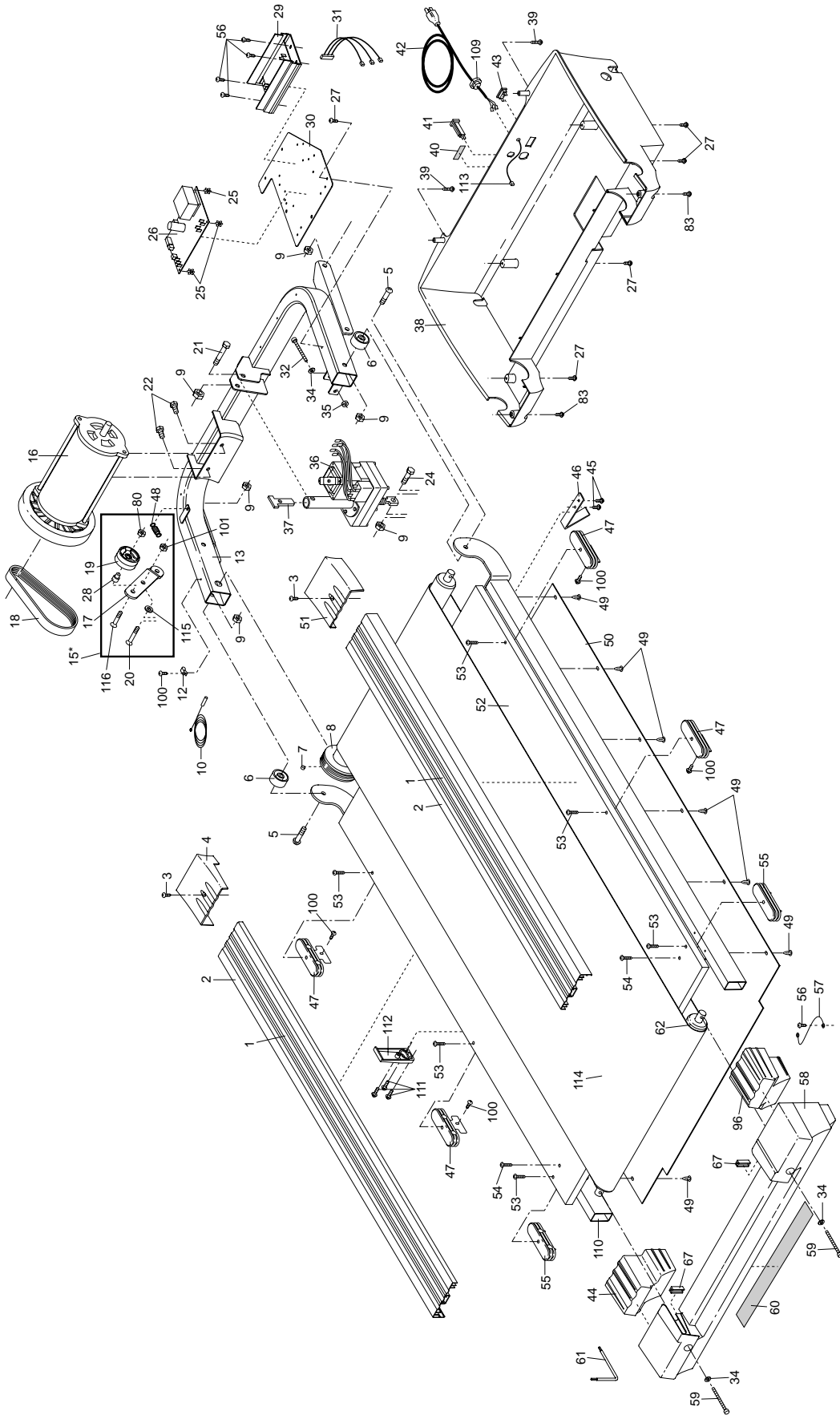

To identify the parts shown on this exploded drawing, refer to the PART LIST on pages 30 and 31 of the USER'S MANUAL.

EXPLODED DRAWING—Model No. NCTL15991

R0702A

