

EXPLODED DRAWING A—Model No. NETL12807.2

R0110A

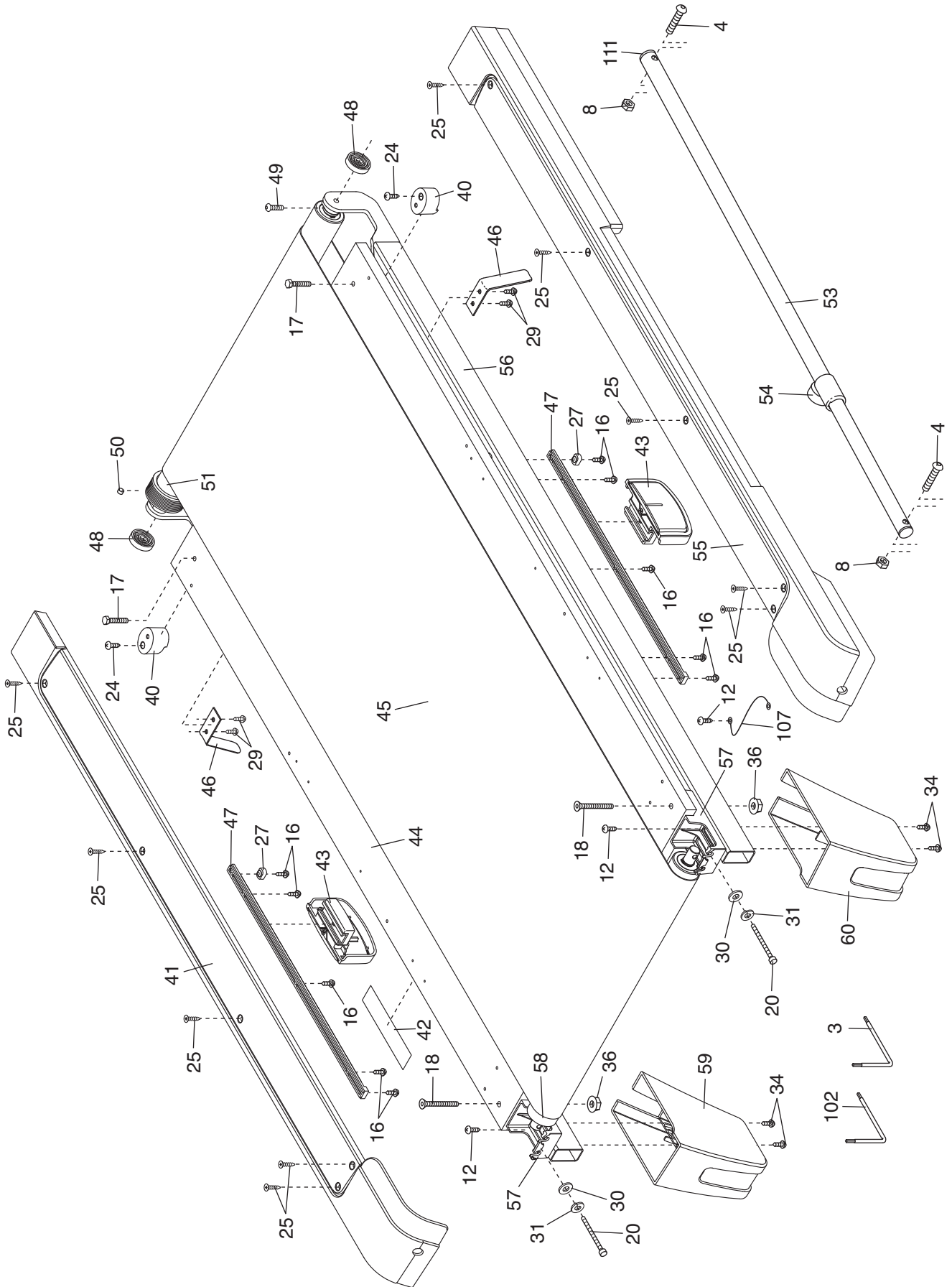

EXPLODED DRAWING B—Model No. NETL12807.2

R0110A

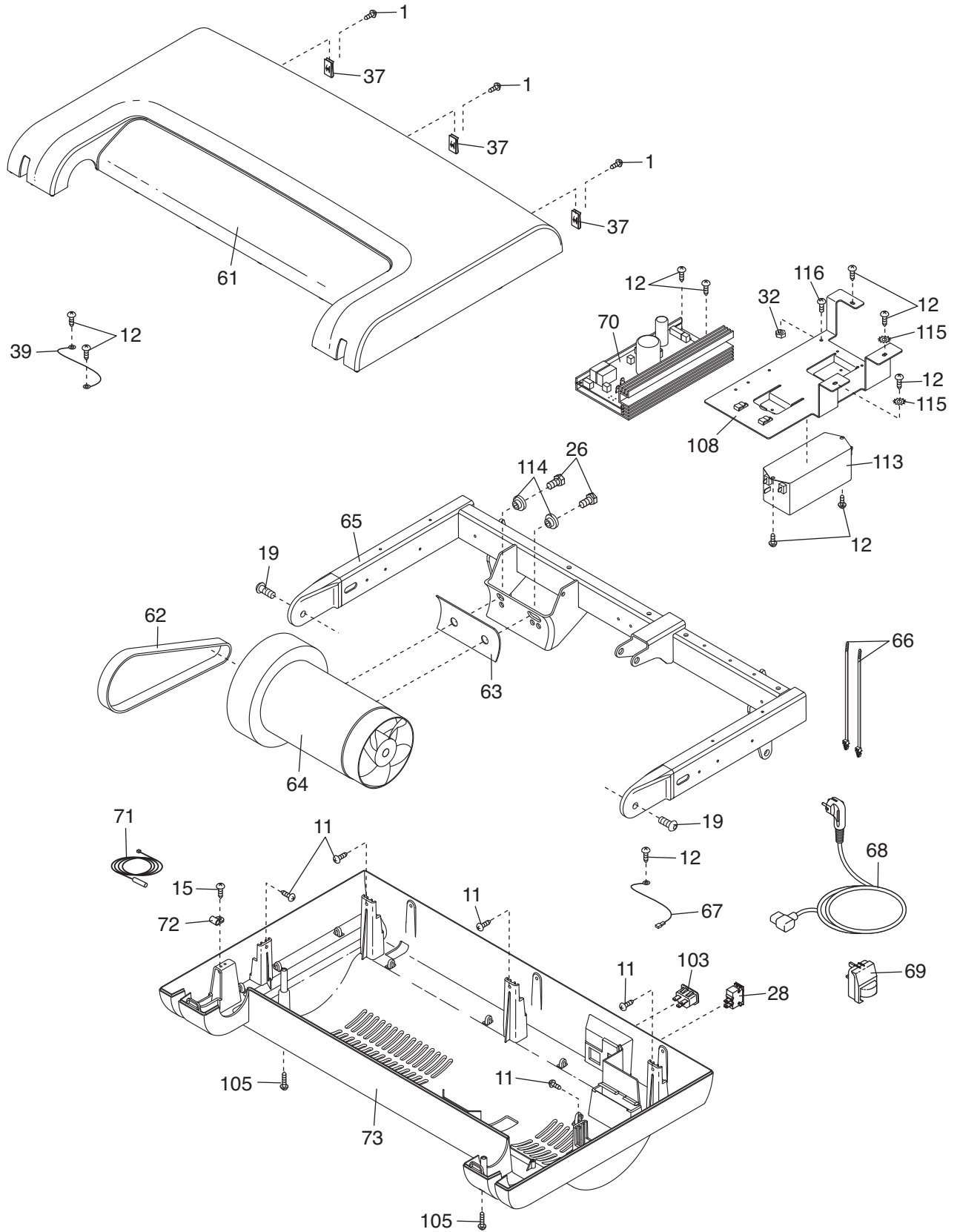

EXPLODED DRAWING C—Model No. NETL12807.2

R0110A

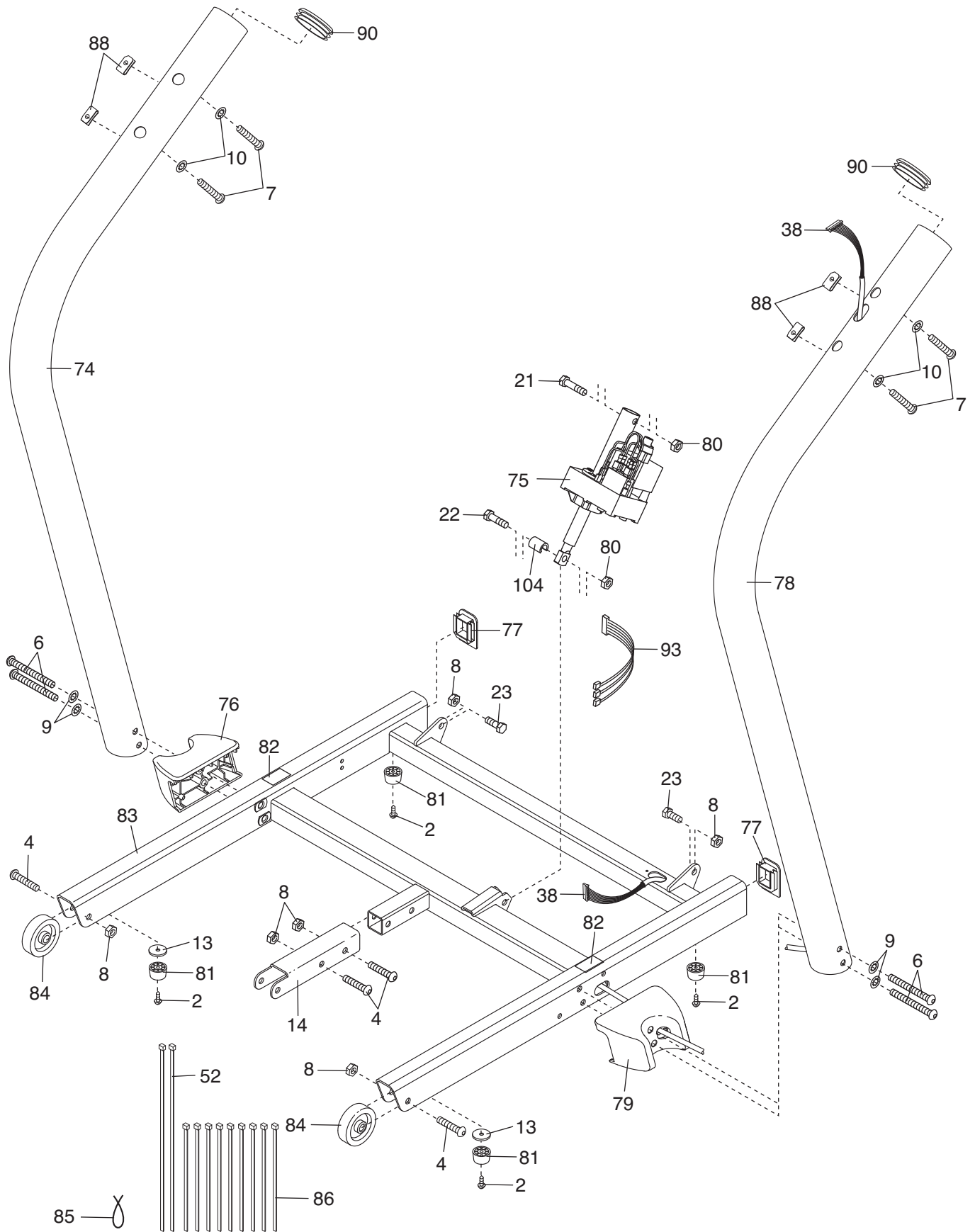

EXPLODED DRAWING D—Model No. NETL12807.2

R0110A

