

DISEGNO ESPLOSO A

N° del Modello NETL15815.2 R0217A

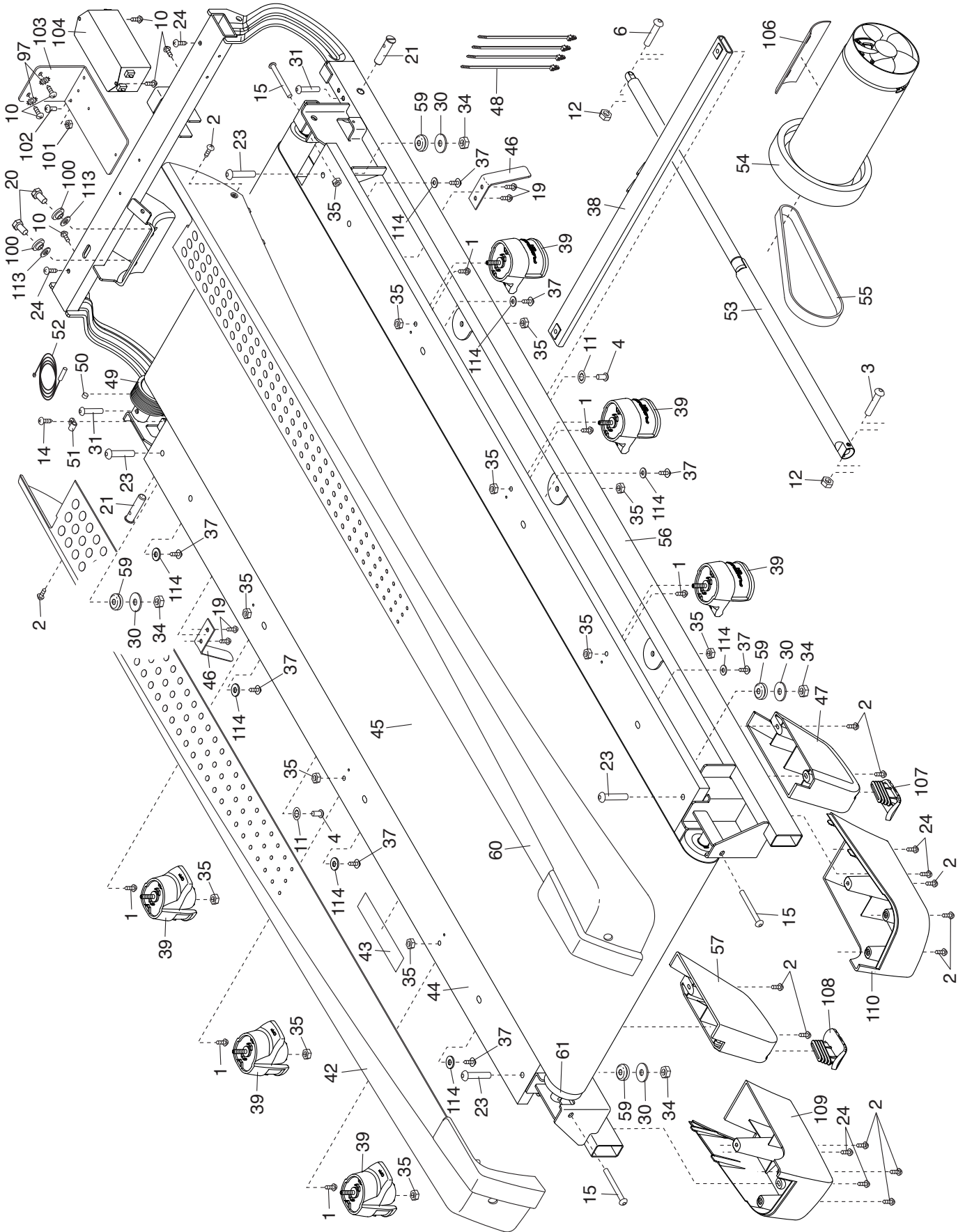

DISEGNO ESPLOSO B

N° del Modello NETL15815.2 R0217A

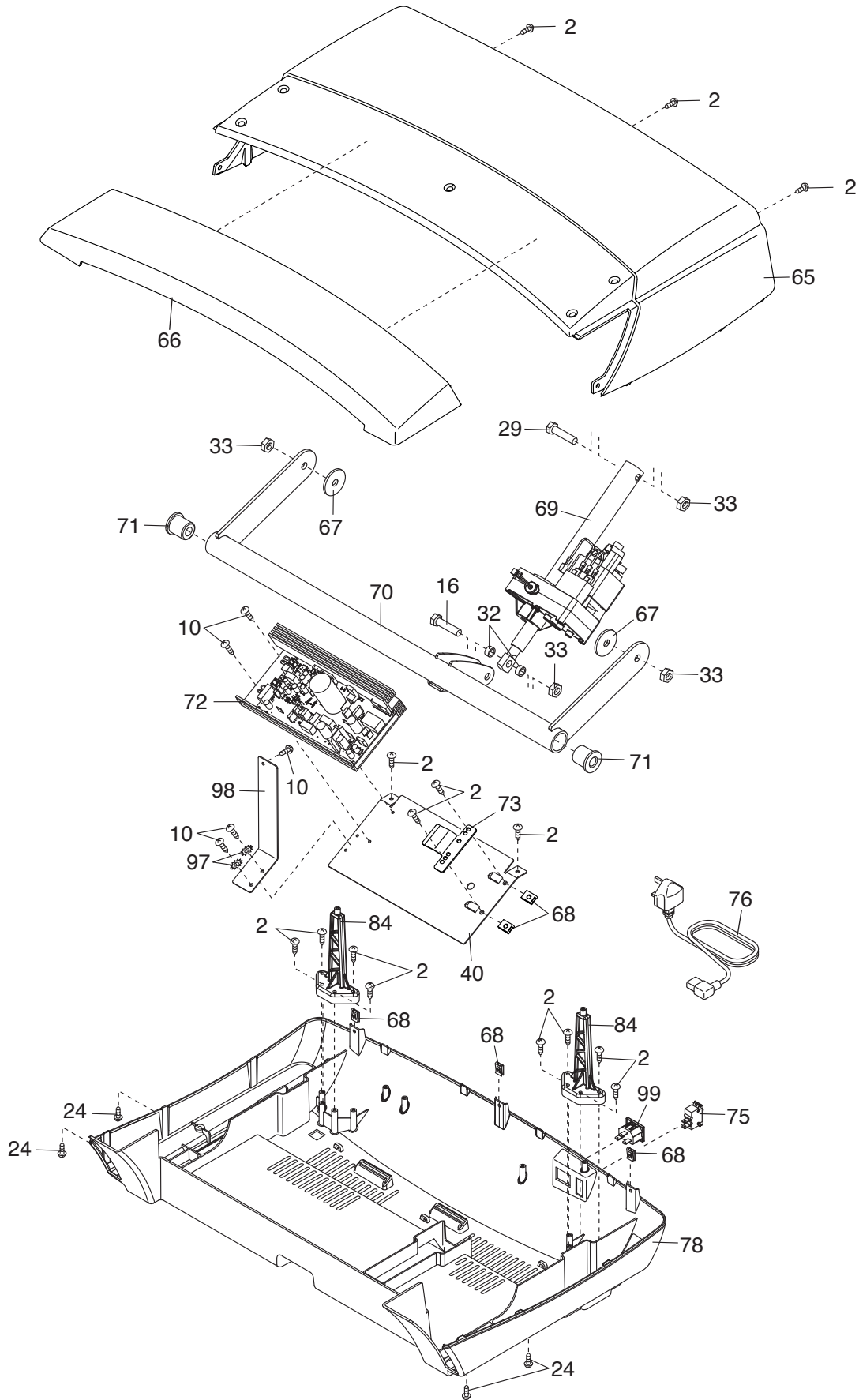

DISEGNO ESPLOSO C

N° del Modello NETL15815.2 R0217A

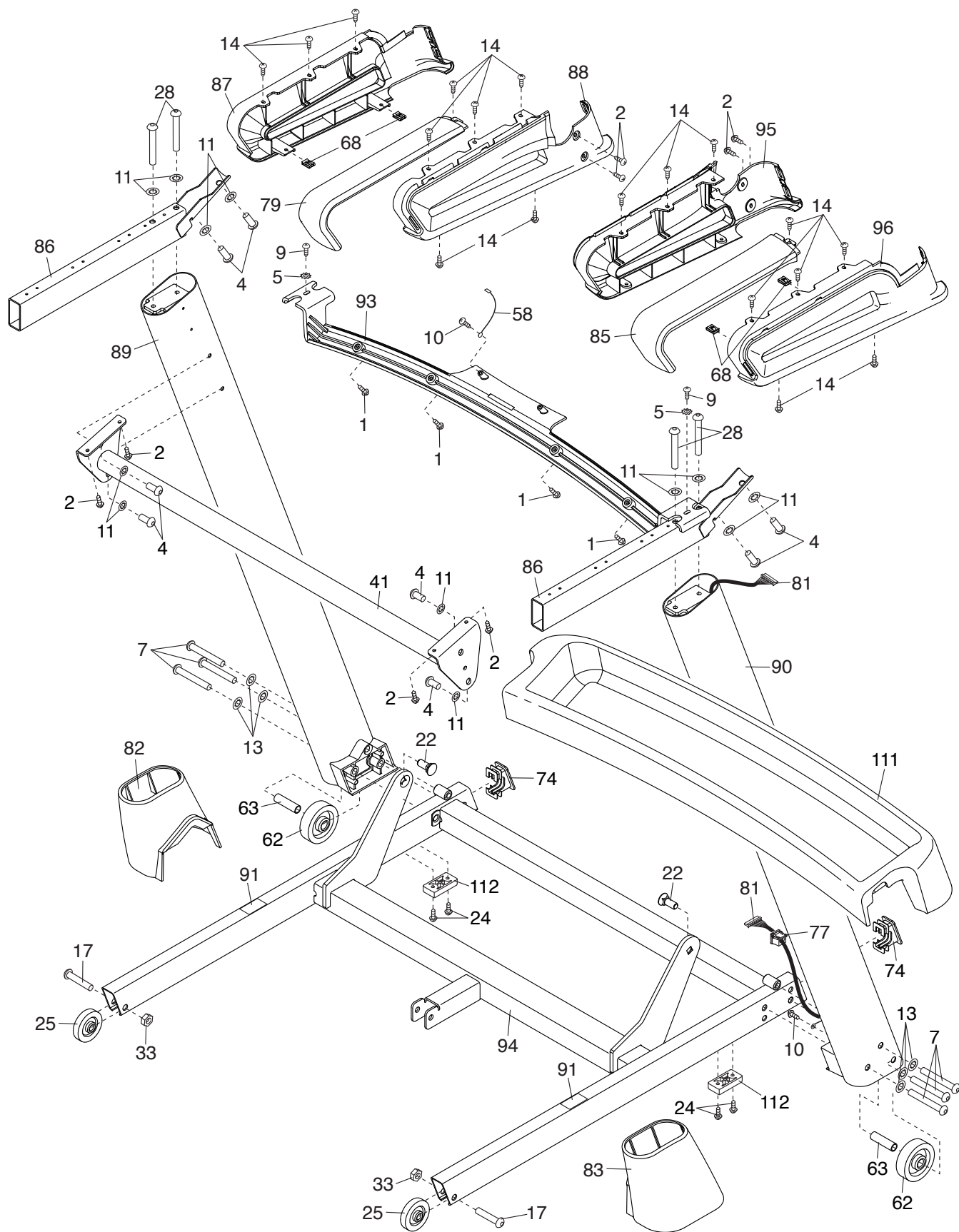

DISEGNO ESPLOSO D

N° del Modello NETL15815.2 R0217A

