

EXPLODED DRAWING A

Model No. NETL17711.1 R1112A

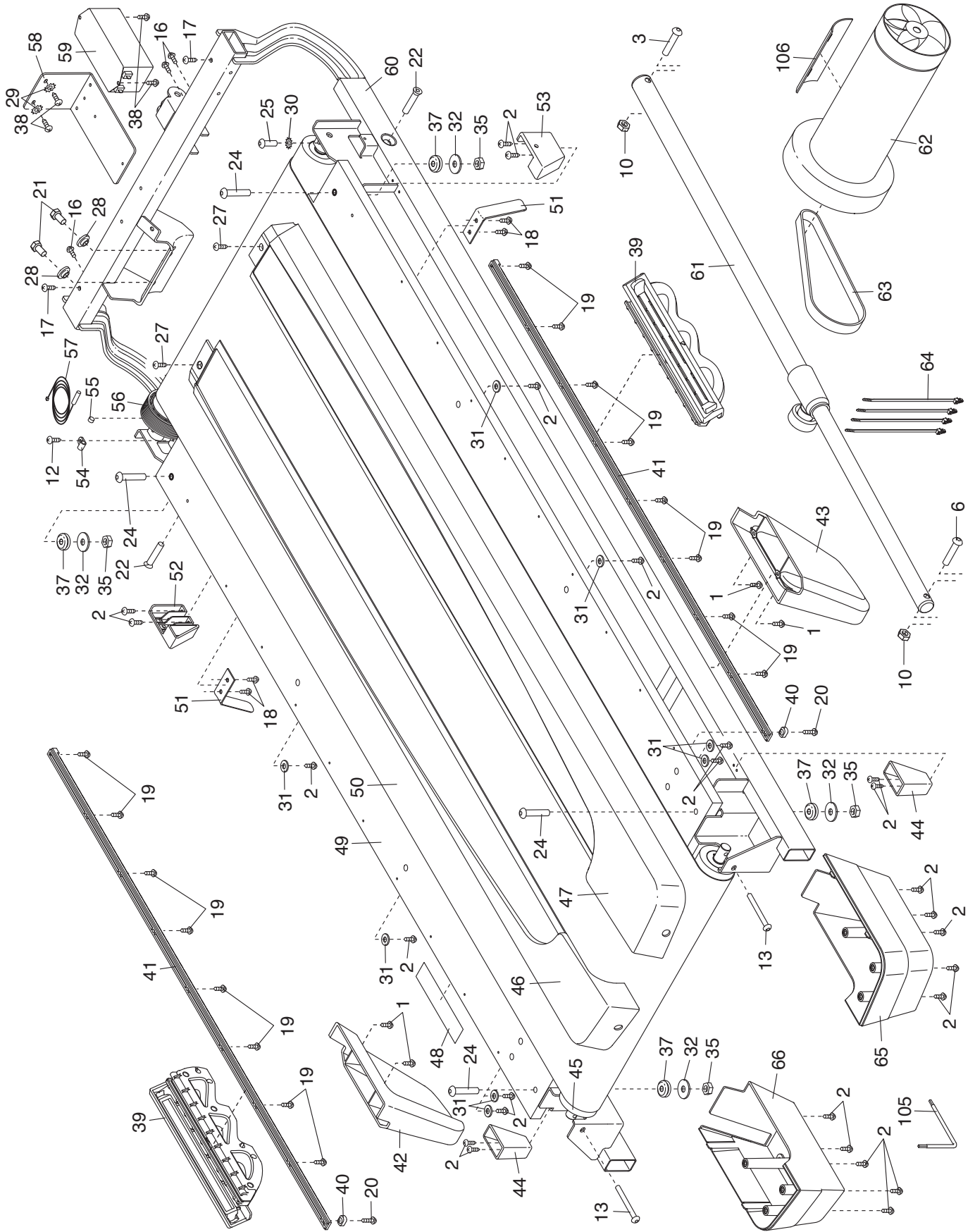

EXPLODED DRAWING B

Model No. NETL17711.1 R1112A

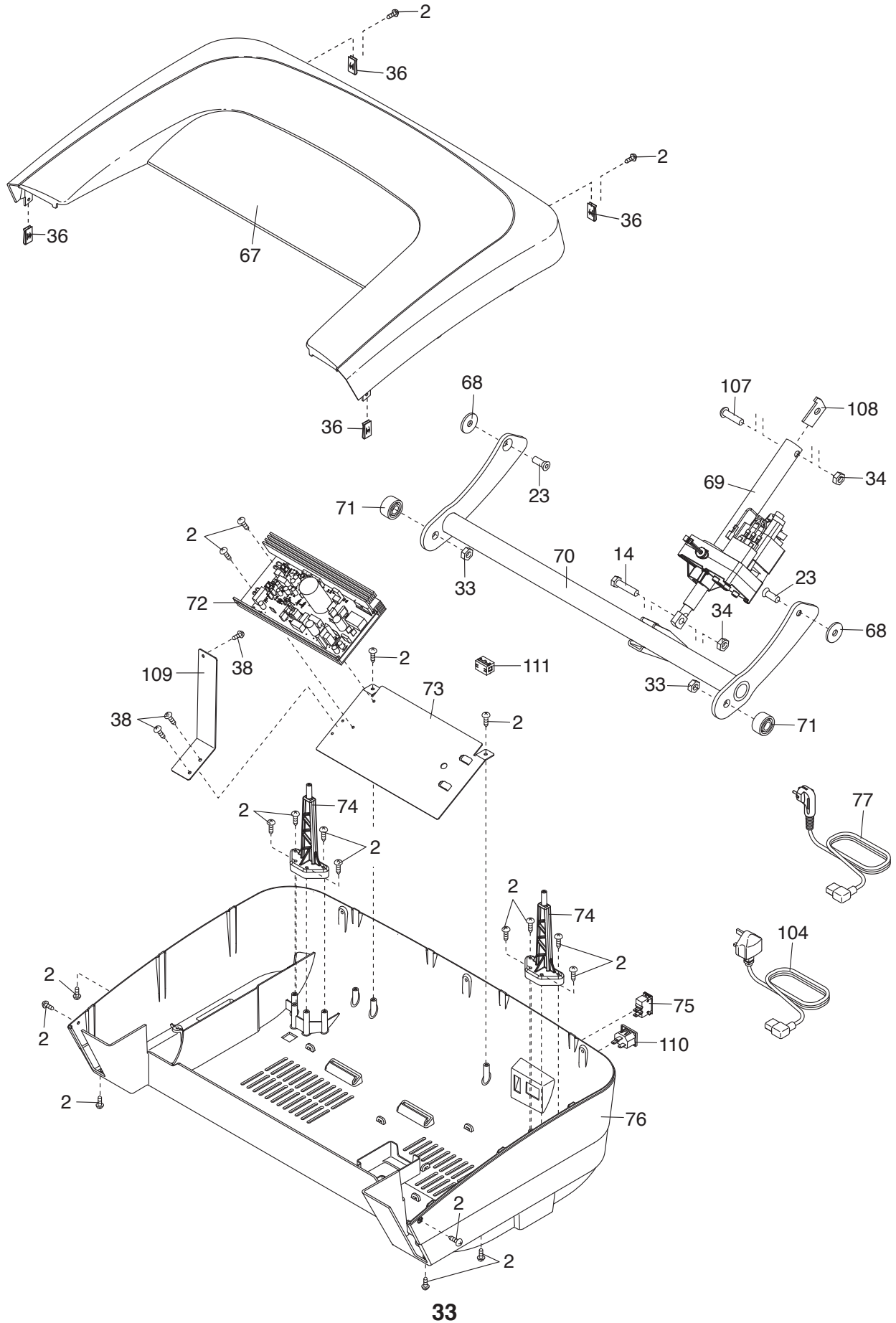

EXPLODED DRAWING C

Model No. NETL17711.1 R1112A

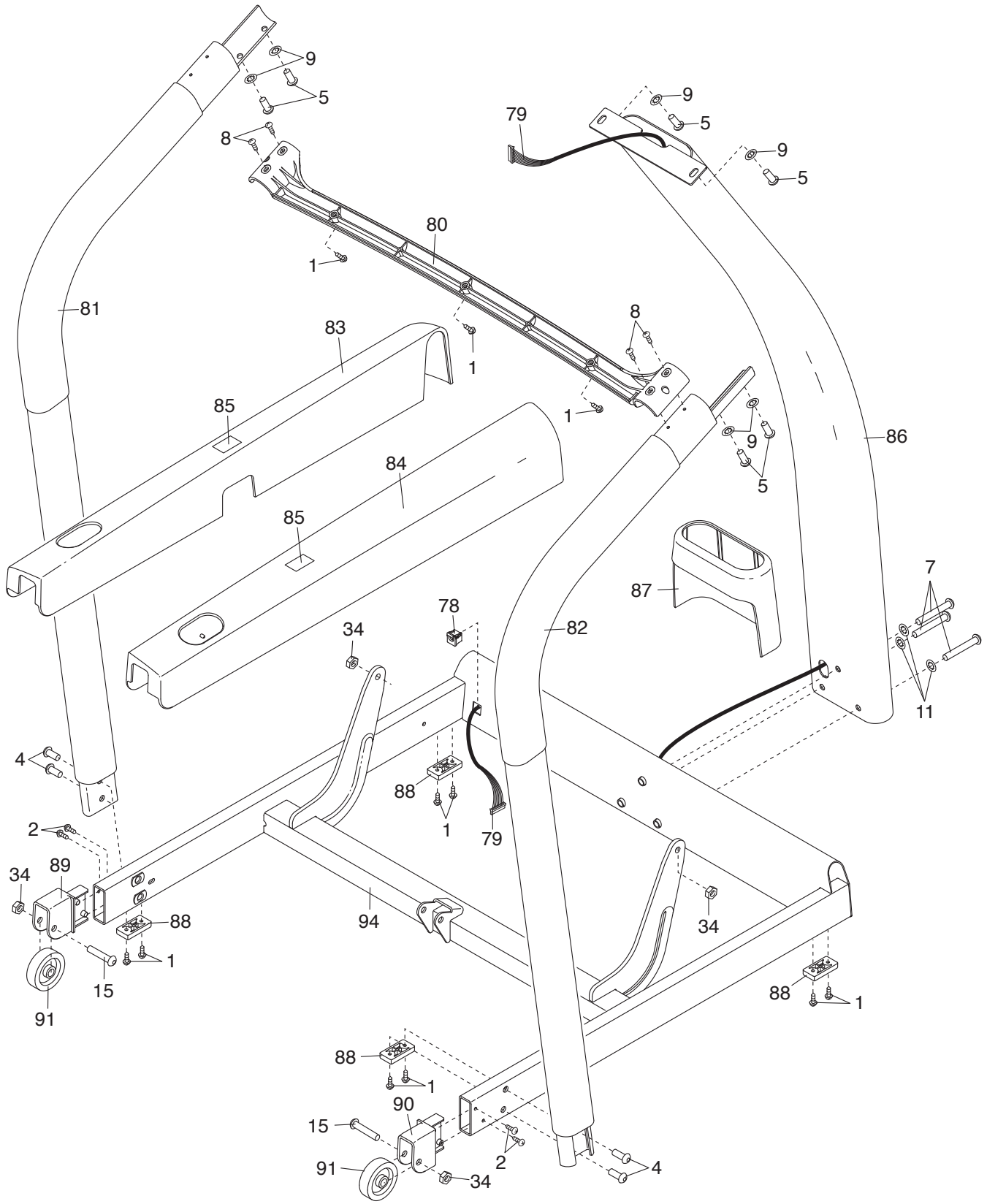

EXPLODED DRAWING D

Model No. NETL17711.1 R1112A

