

EXPLODED DRAWING A—Model No. NTEL00607.0

R0308A

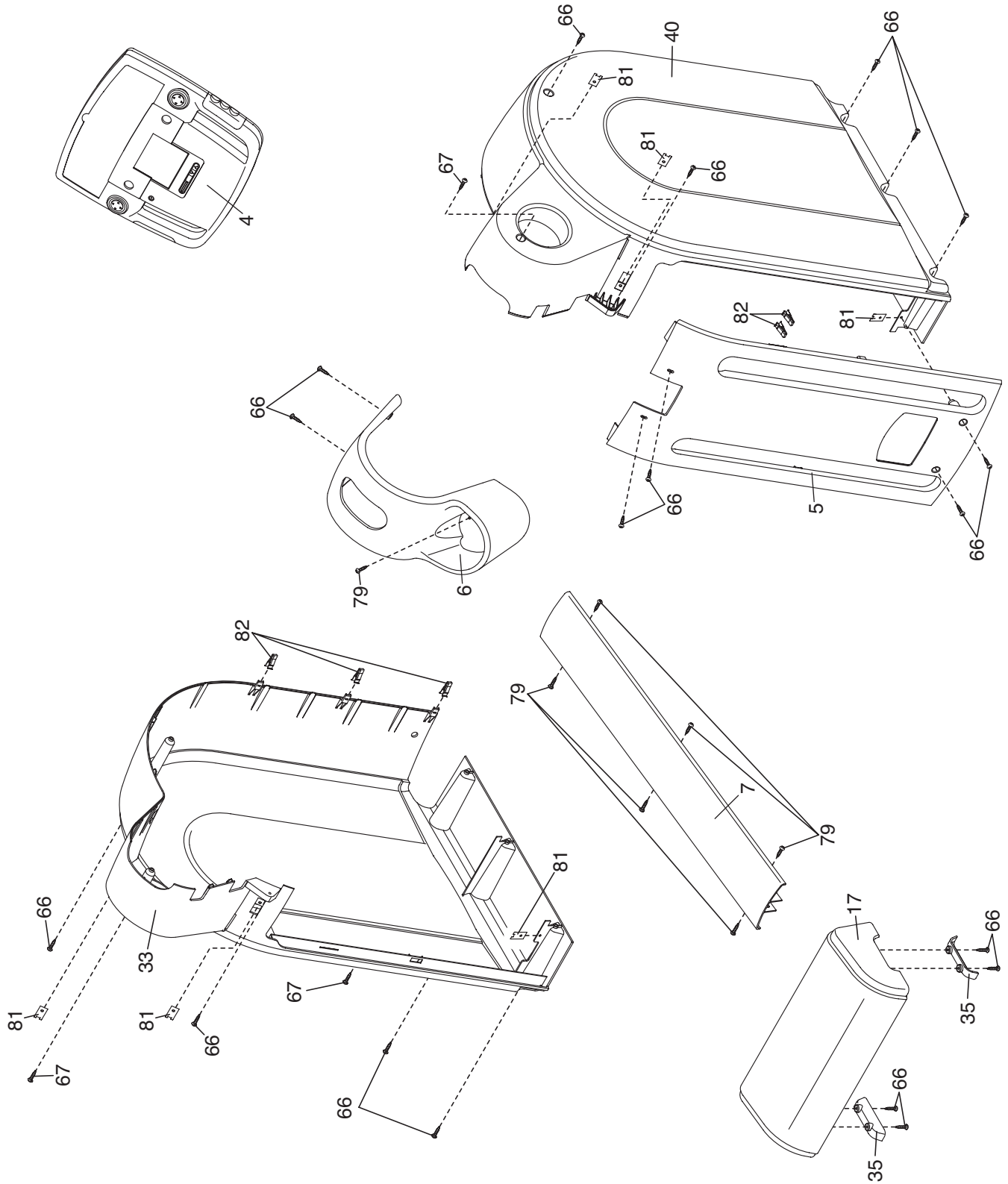

EXPLODED DRAWING B—Model No. NTEL00607.0

R0308A

