

EXPLODED DRAWING A—Model No. NTEL07808.1

R1009A

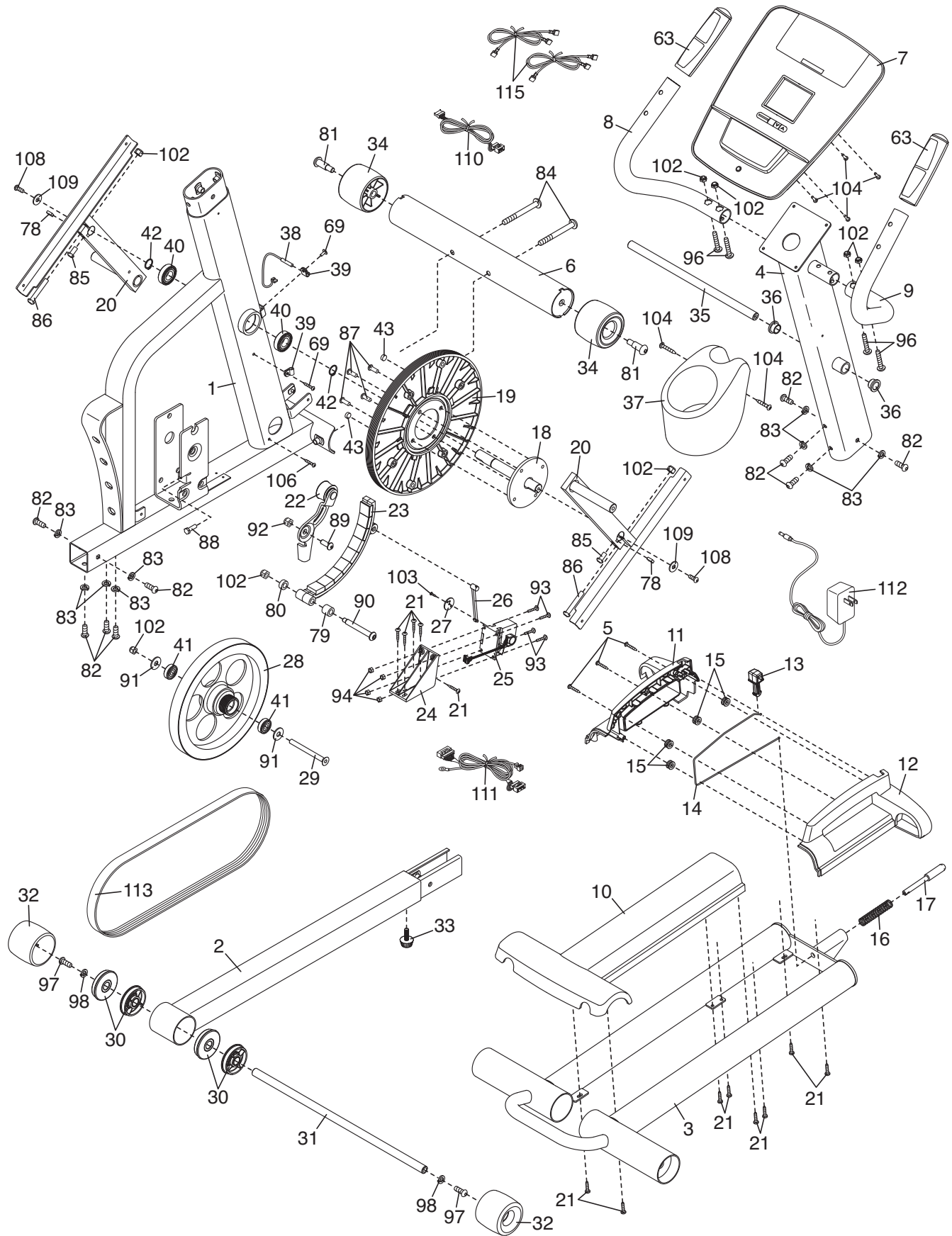

EXPLODED DRAWING B—Model No. NTEL07808.1

R1009A

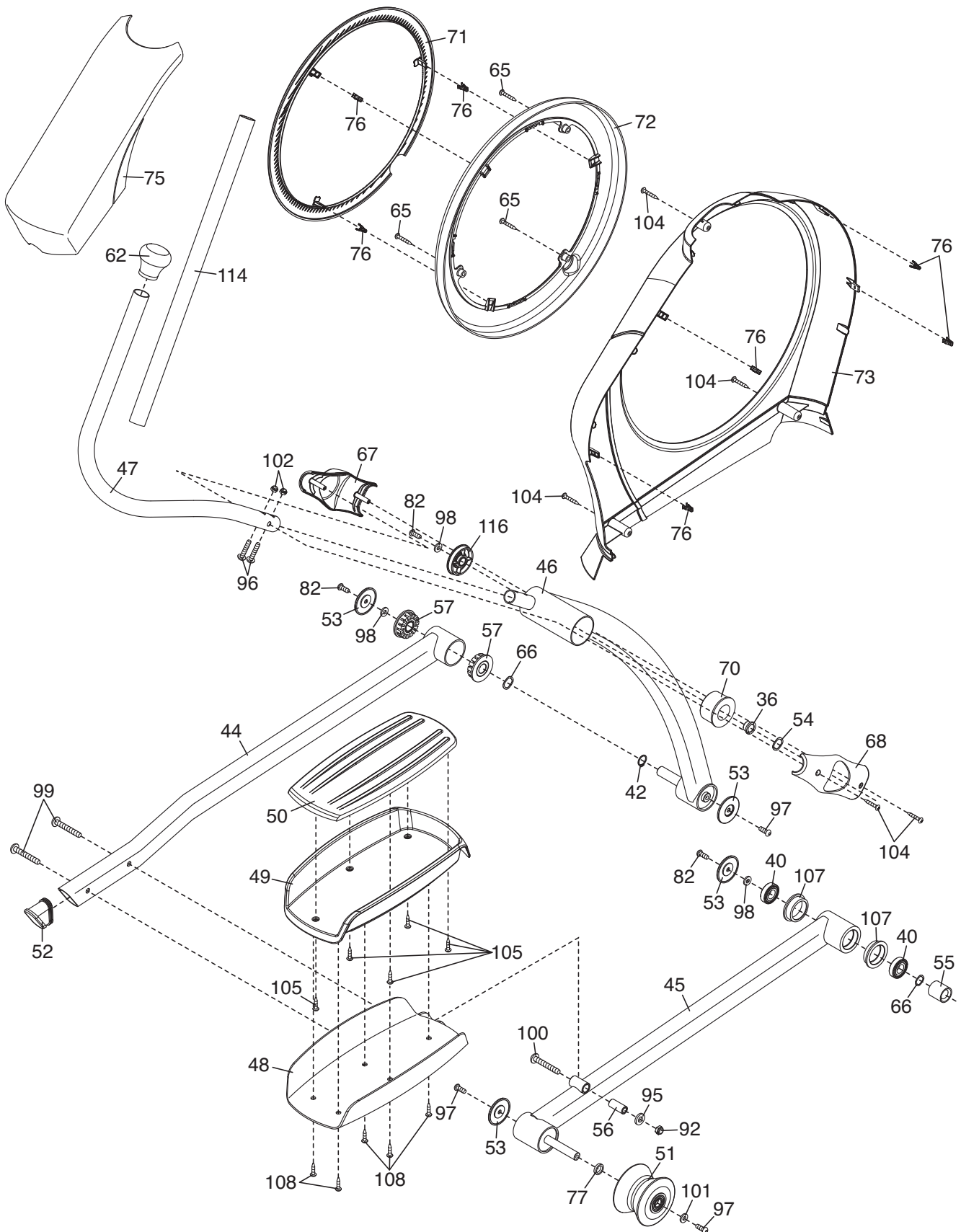

EXPLODED DRAWING C—Model No. NTEL07808.1

R1009A

