

EXPLODED DRAWING A—Model No. NTEL09809.0

R0109A

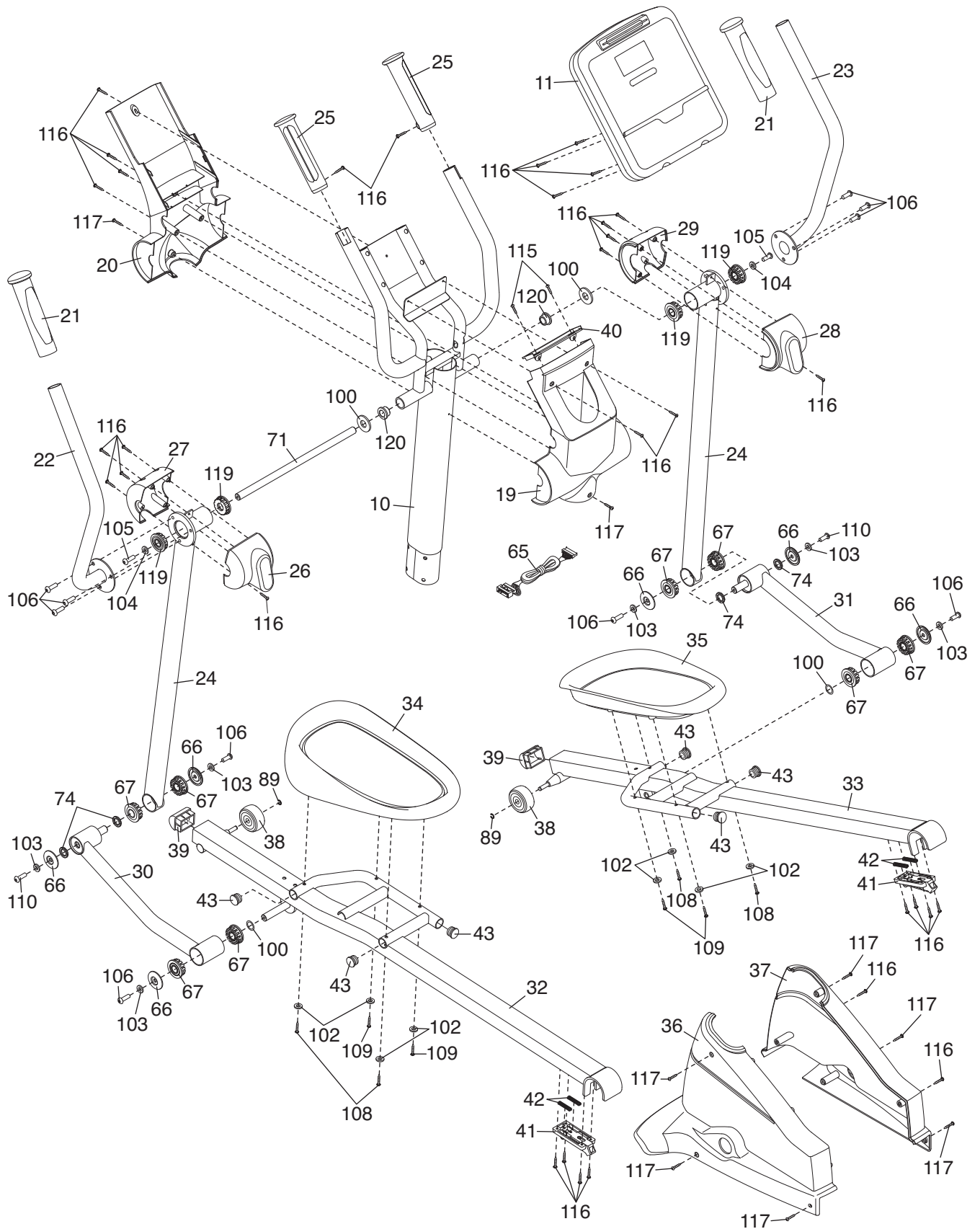

EXPLODED DRAWING B—Model No. NTEL09809.0

R0109A

