

# EXPLODED DRAWING A—Model No. NTEL4255.2

R0207A

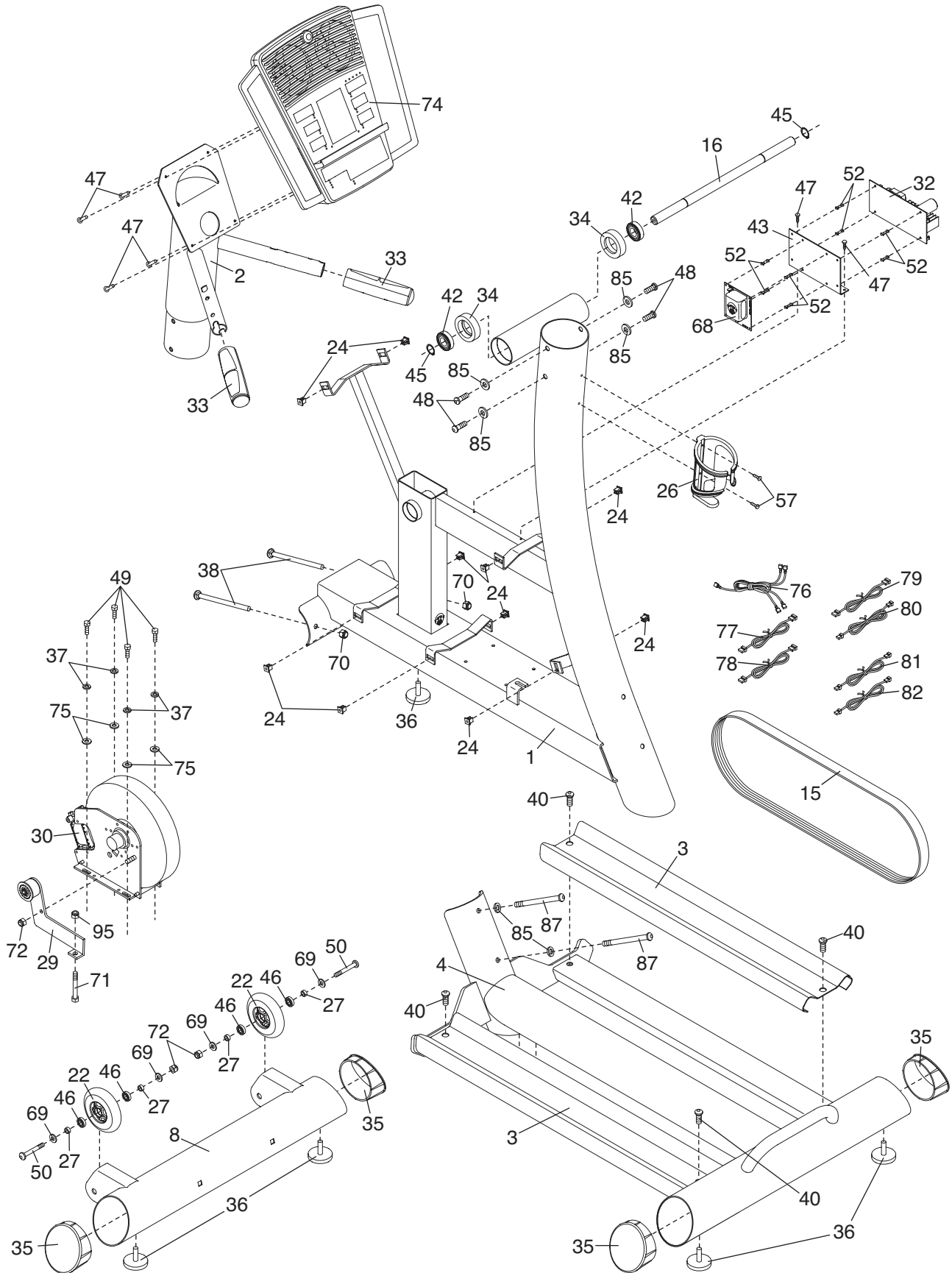

# EXPLODED DRAWING B—Model No. NTEL4255.2

R0207A

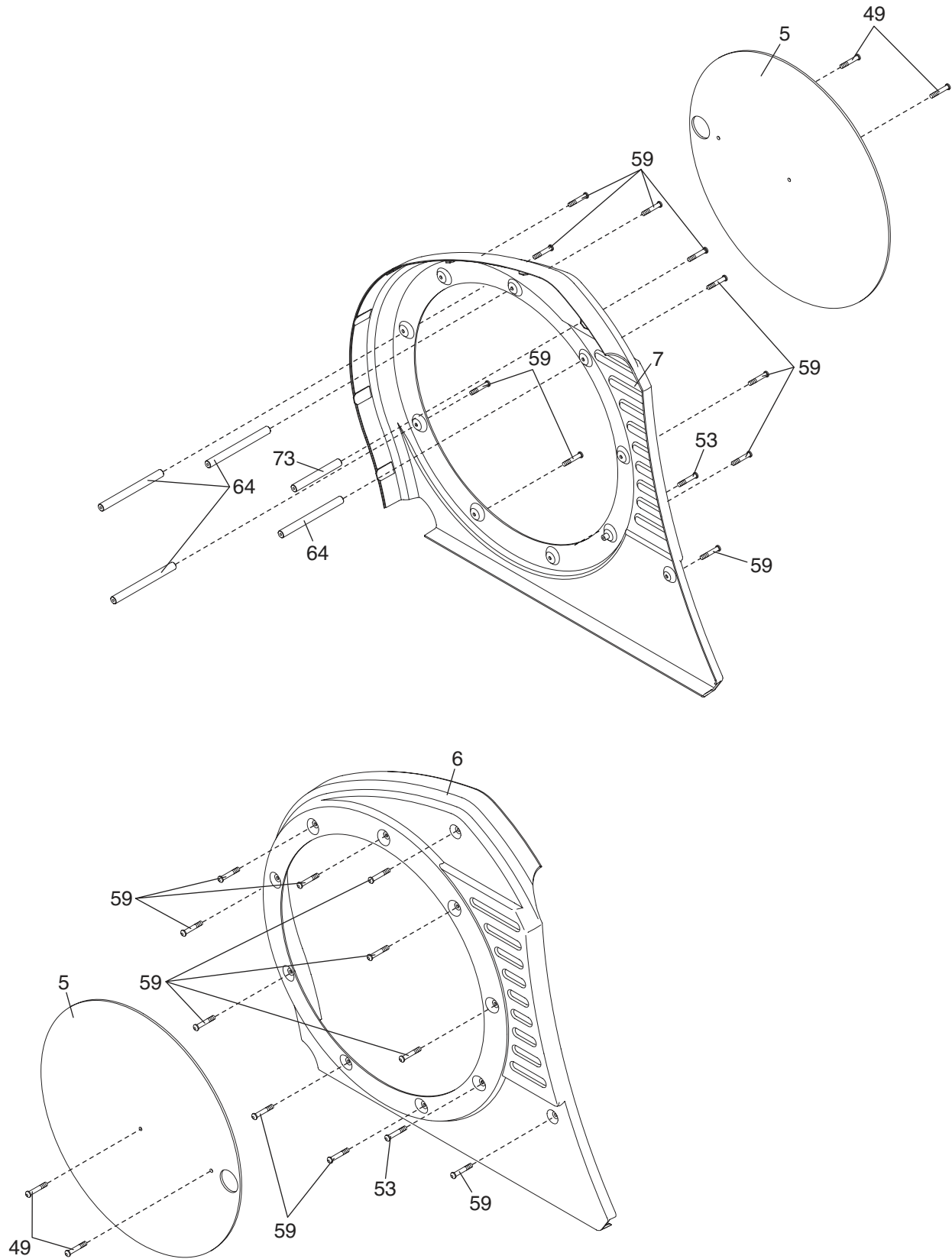

# EXPLODED DRAWING C—Model No. NTEL4255.2

R0207A

