

EXPLODED DRAWING A

Model No. NTEL71320.1 R0121A

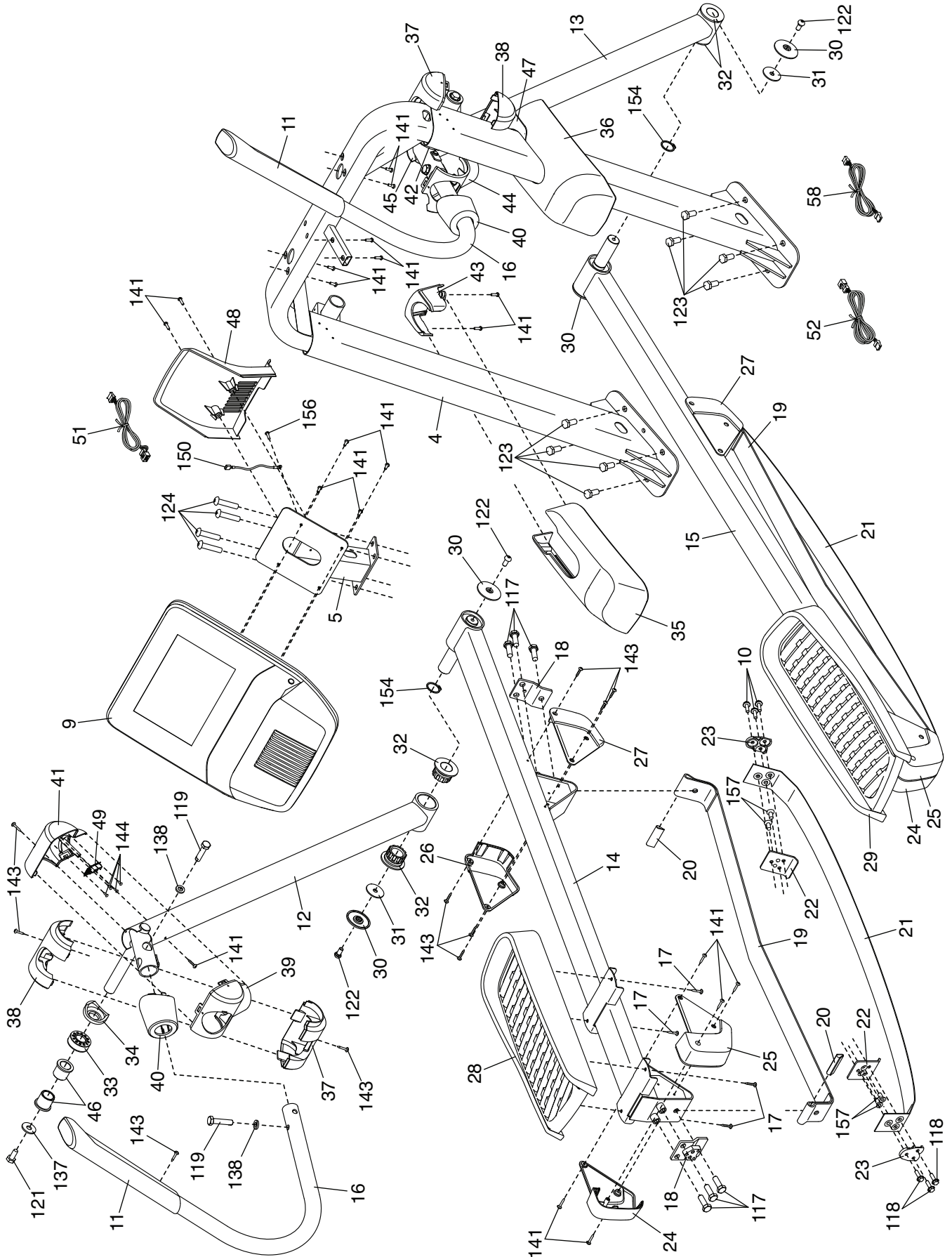

EXPLODED DRAWING B

Model No. NTEL71320.1 R0121A

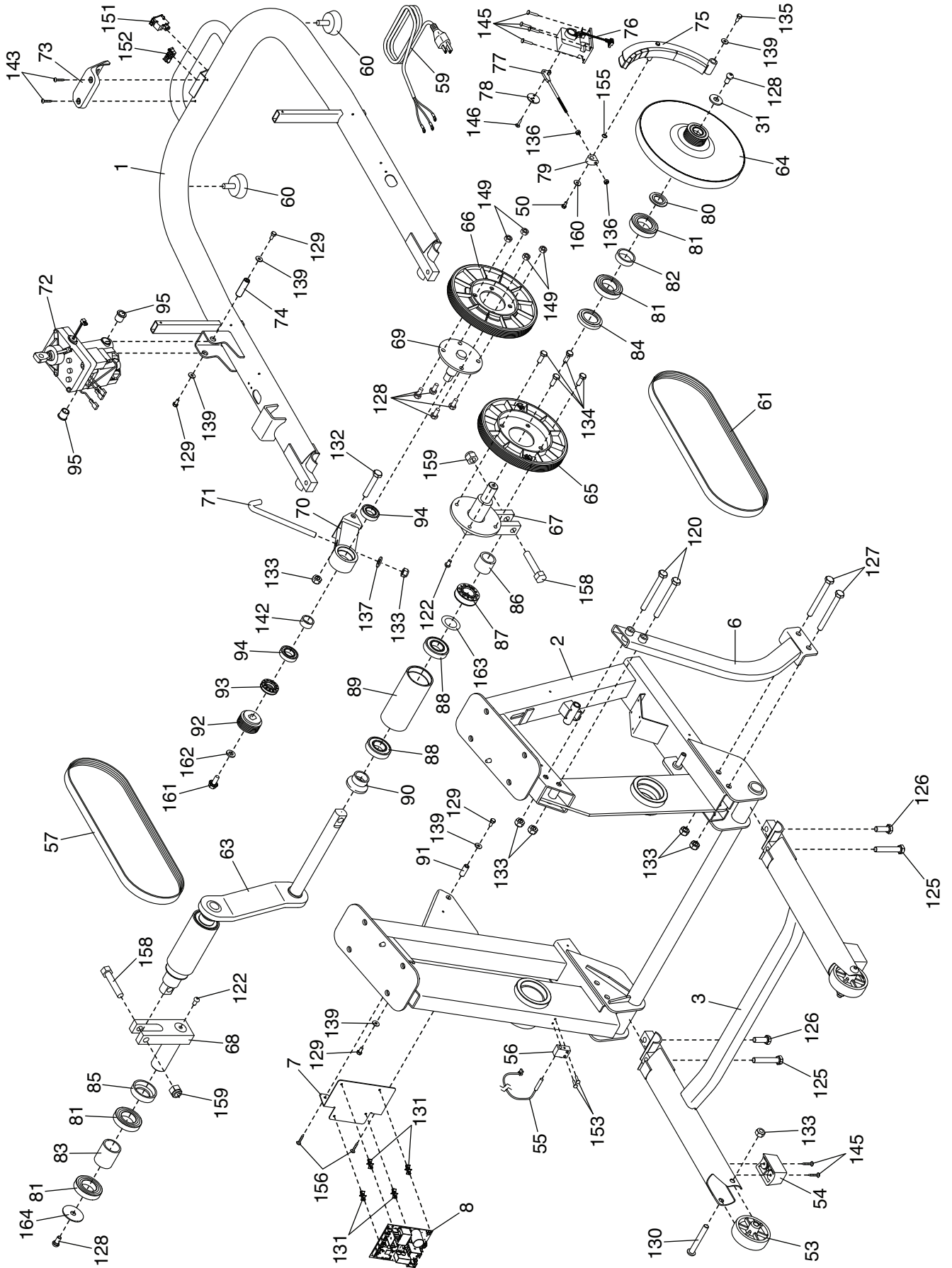

EXPLODED DRAWING C

Model No. NTEL71320.1 R0121A

