

EXPLODED DRAWING A

Model No. NTEL71320.5 R0923A

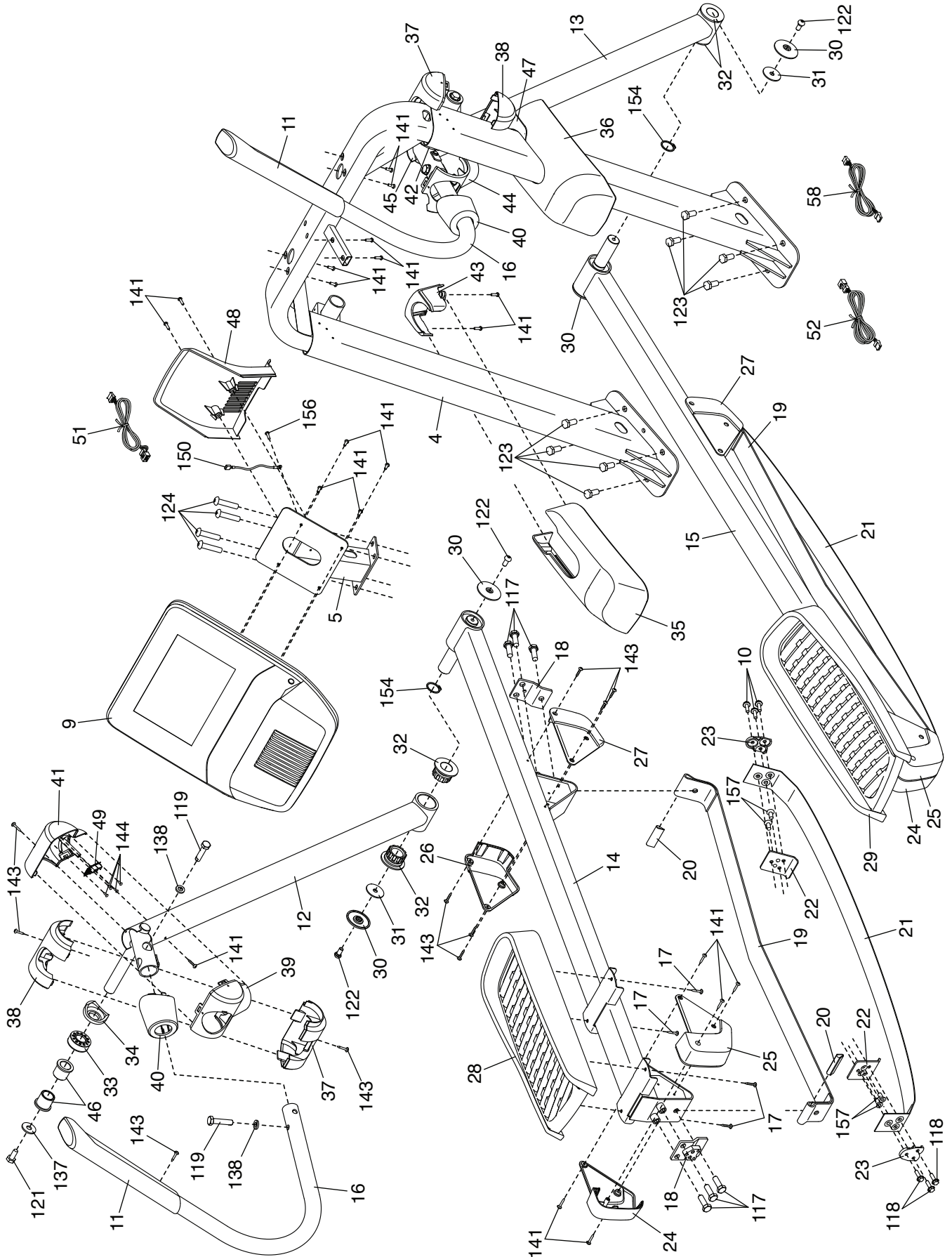

EXPLODED DRAWING B

Model No. NTEL71320.5 R0923A

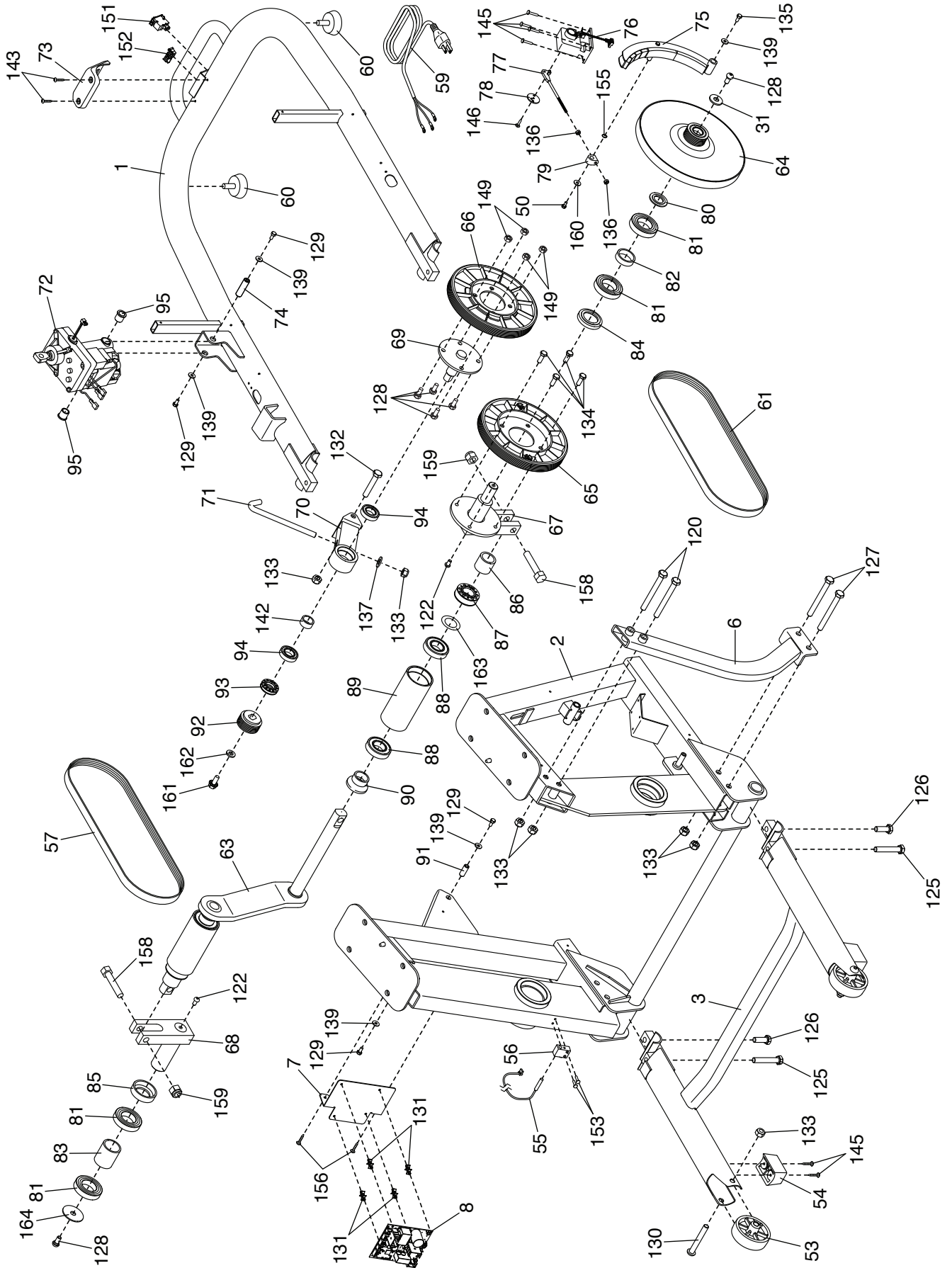

EXPLODED DRAWING C

Model No. NTEL71320.5 R0923A

