

# EXPLODED DRAWING A

Model No. NTEL71418.2 R1018A

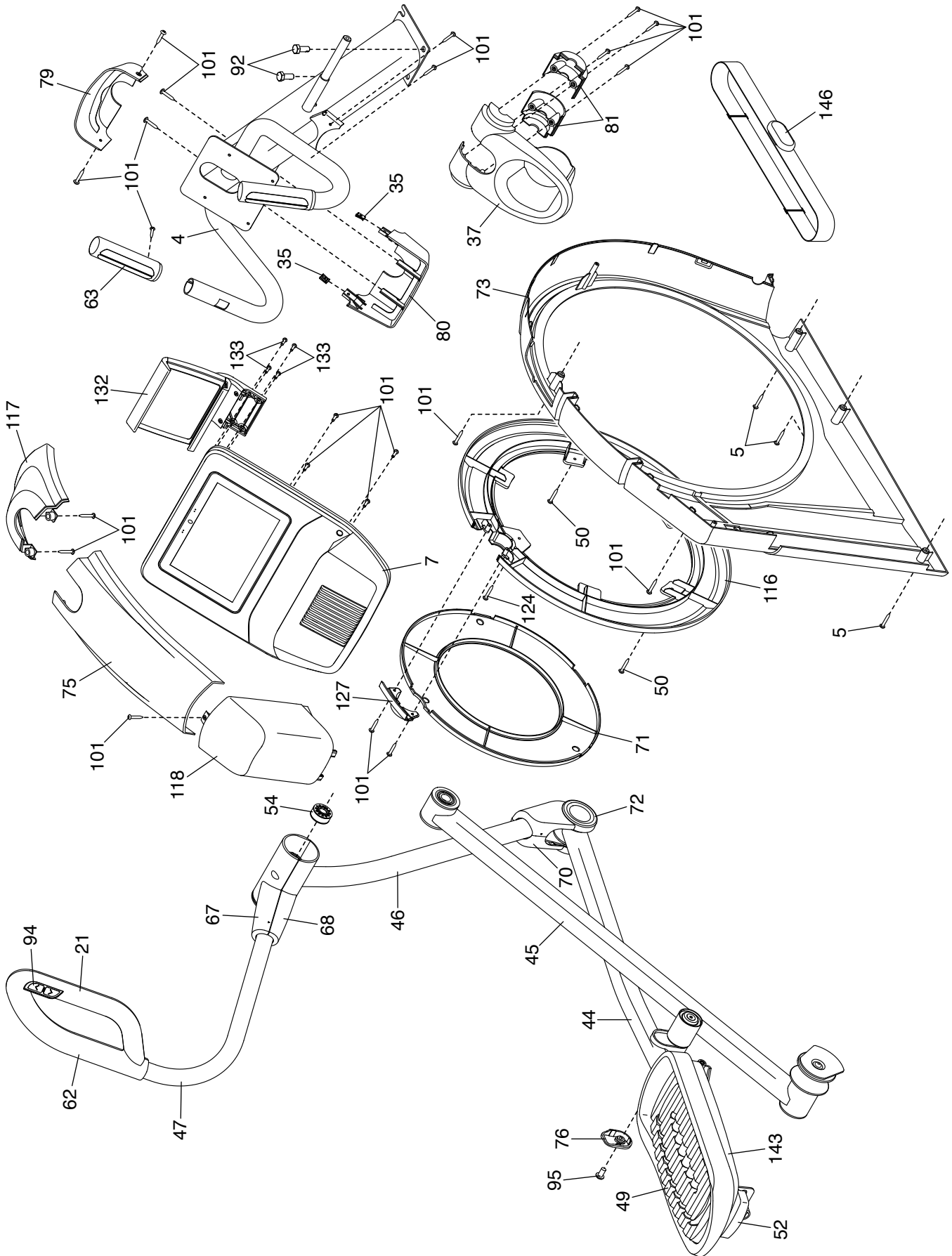

# EXPLODED DRAWING B

Model No. NTEL71418.2 R1018A

