

EXPLODED DRAWING A

Model No. NTEL71418.4 R1218A

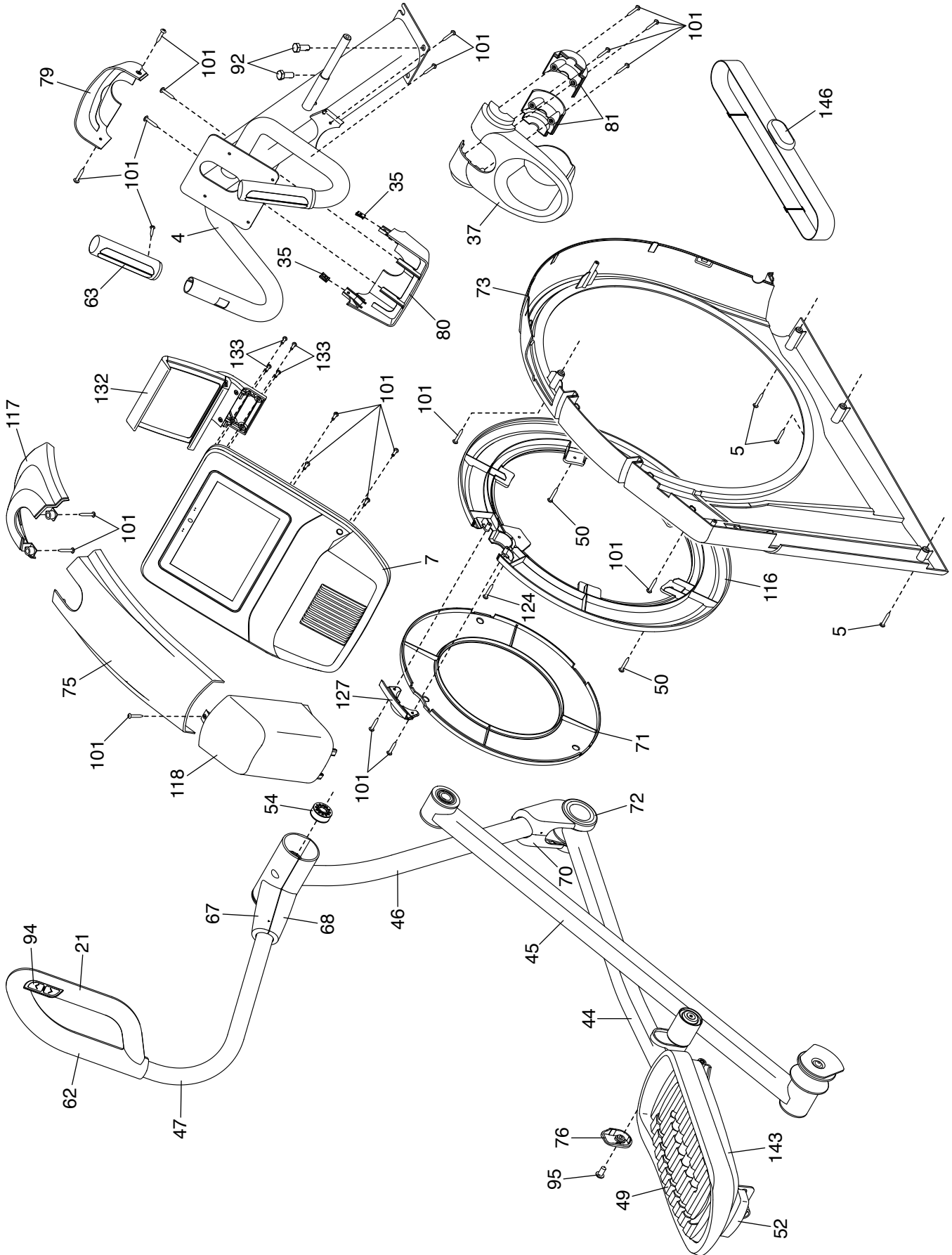

EXPLODED DRAWING B

Model No. NTEL71418.4 R1218A

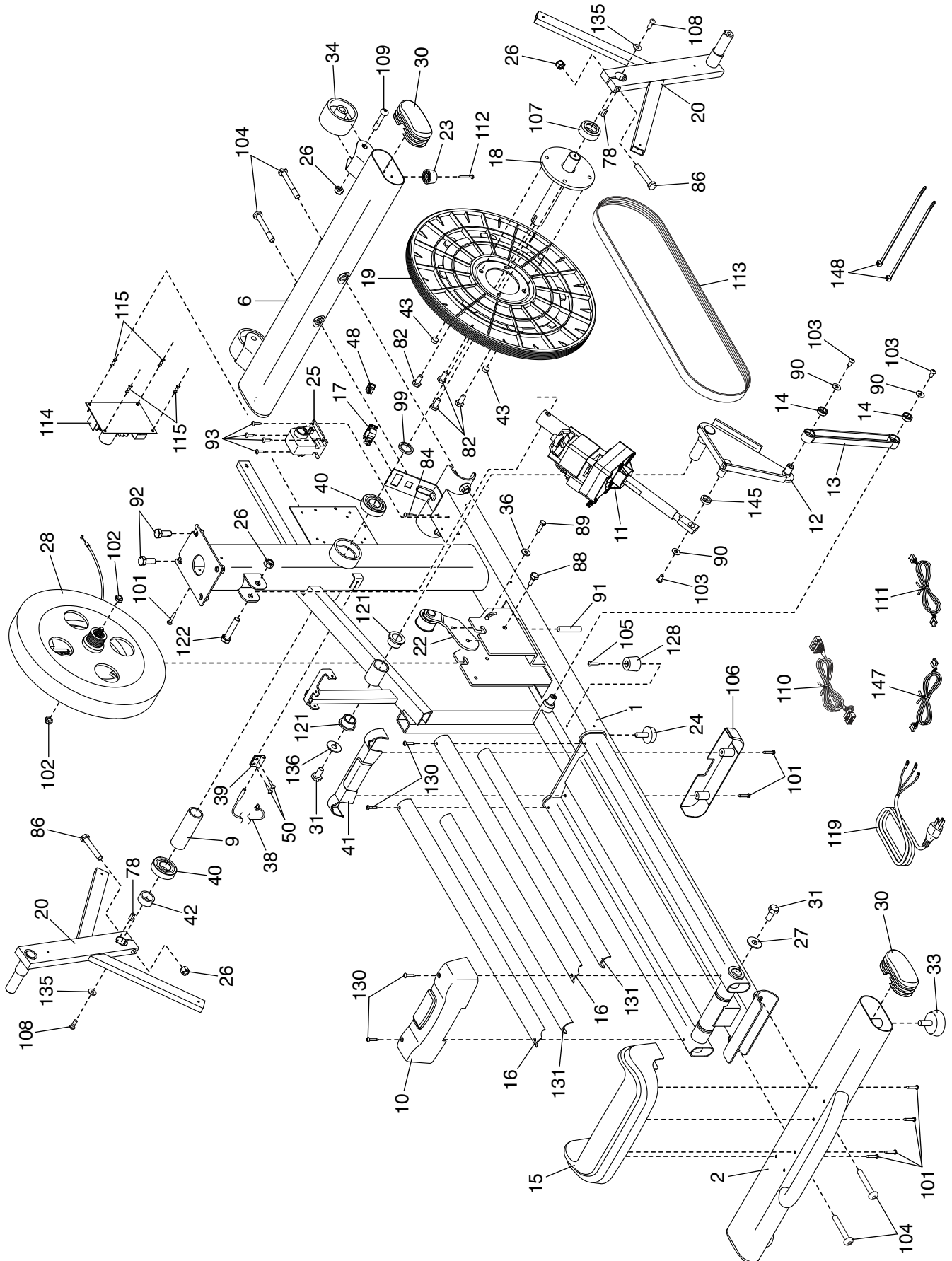

EXPLODED DRAWING C

Model No. NTEL71418.4 R1218A

