

EXPLODED DRAWING A

Model No. NTEL71423.3 R0723A

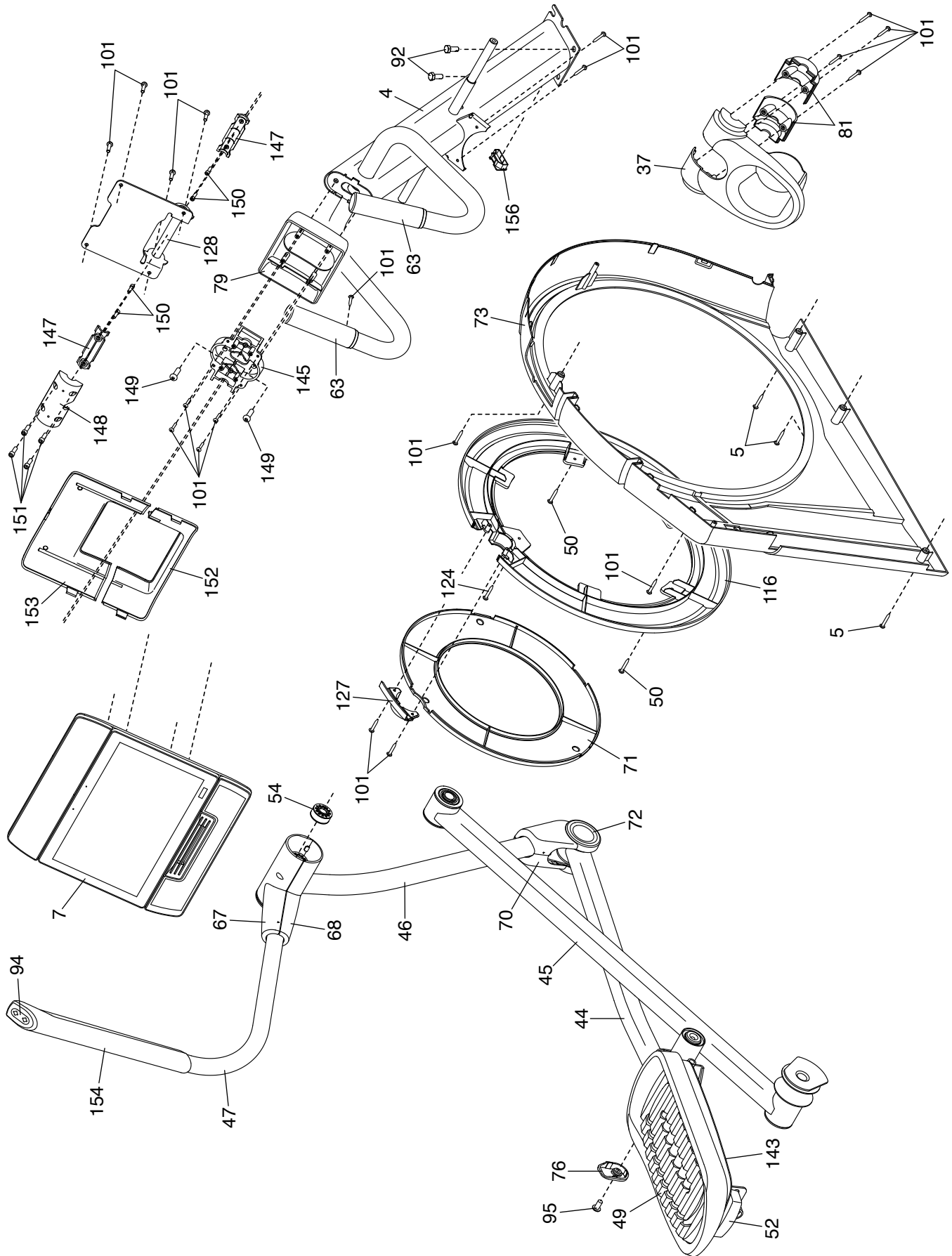

EXPLODED DRAWING B

Model No. NTEL71423.3 R0723A

