

EXPLODED DRAWING A

Model No. NTEL71612.2 R0513A

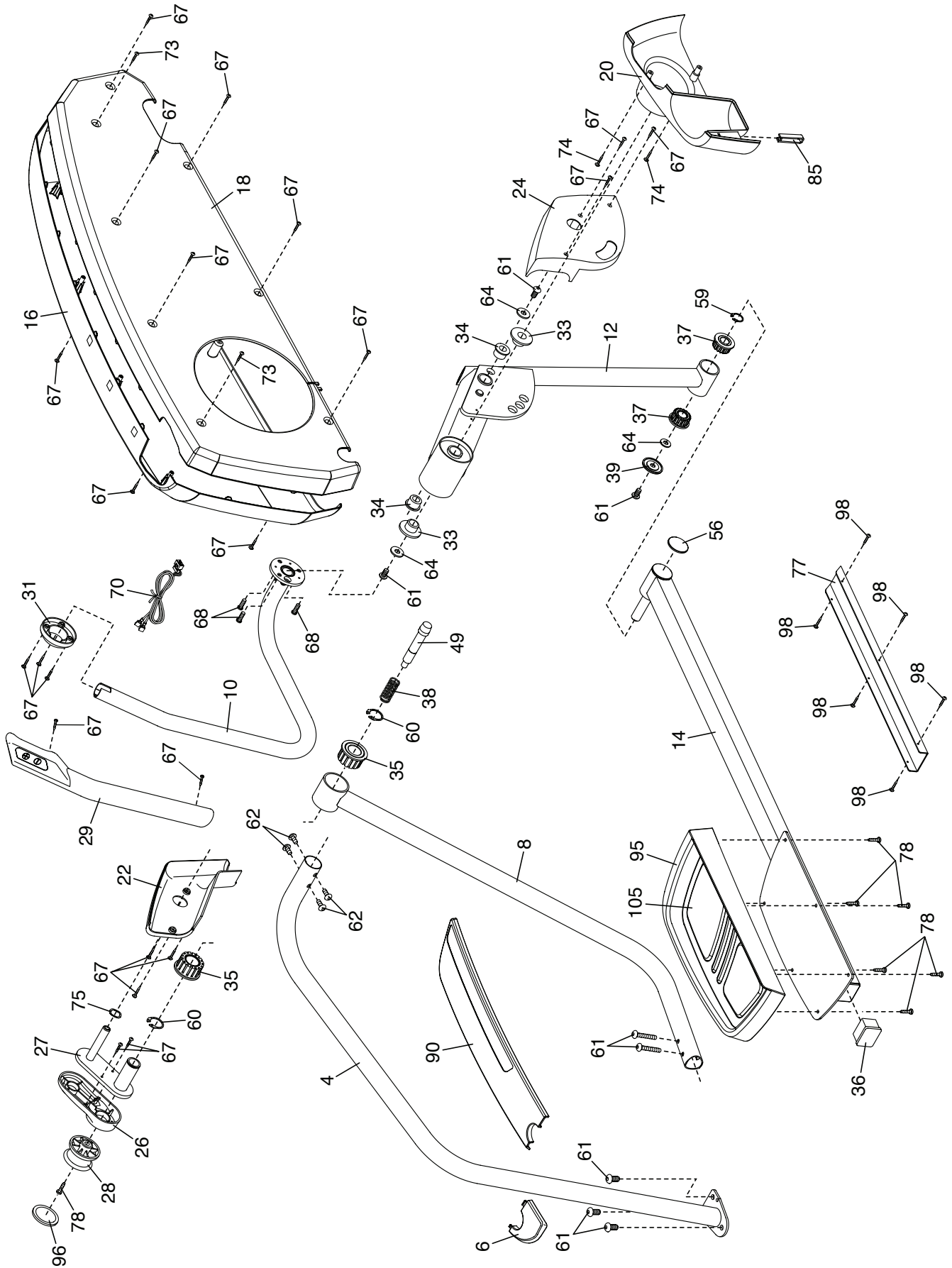

EXPLODED DRAWING B

Model No. NTEL71612.2 R0513A

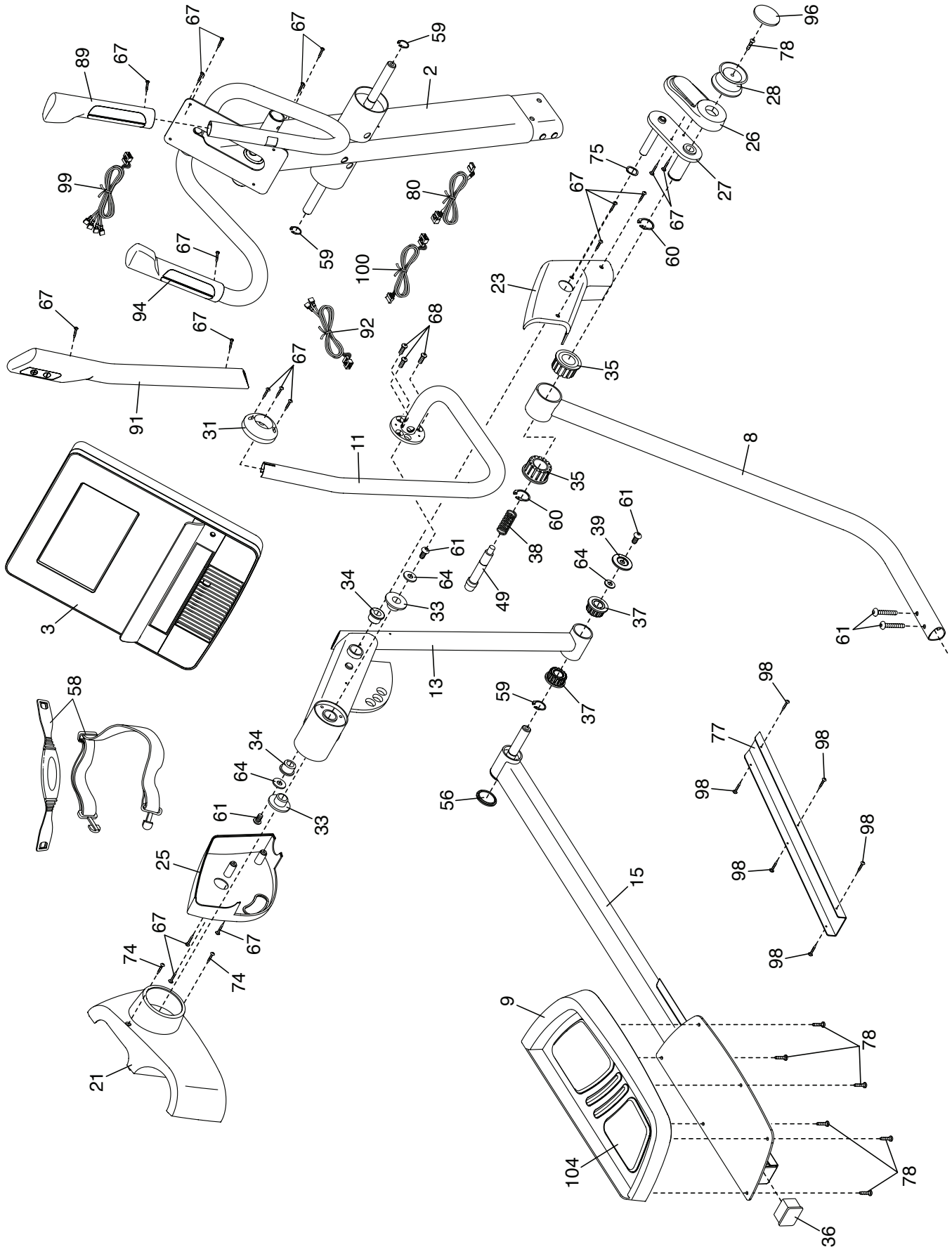

EXPLODED DRAWING C

Model No. NTEL71612.2 R0513A

