

EXPLODED DRAWING A

Model No. NTEL71612.3 R0813A

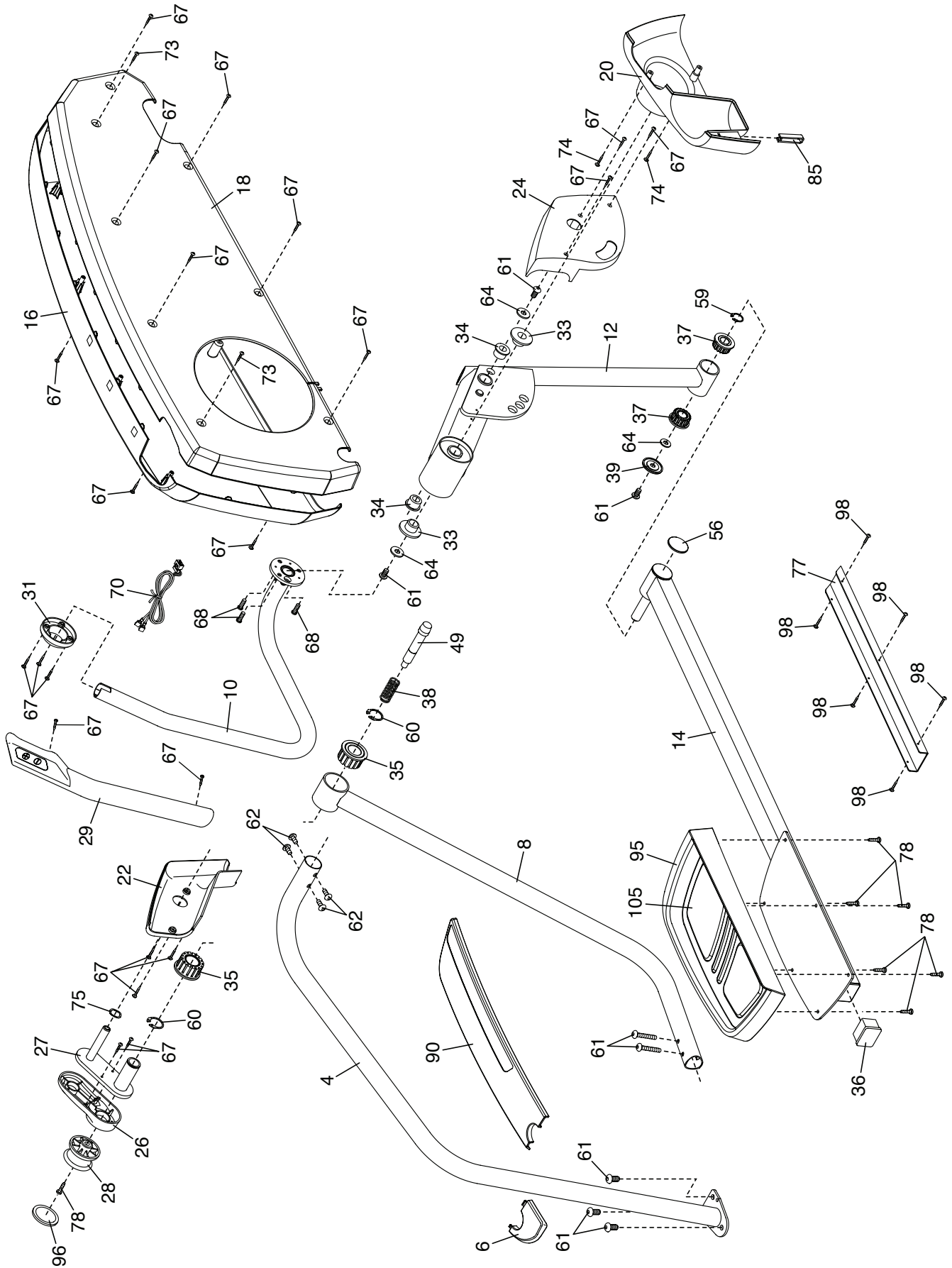

EXPLODED DRAWING B

Model No. NTEL71612.3 R0813A

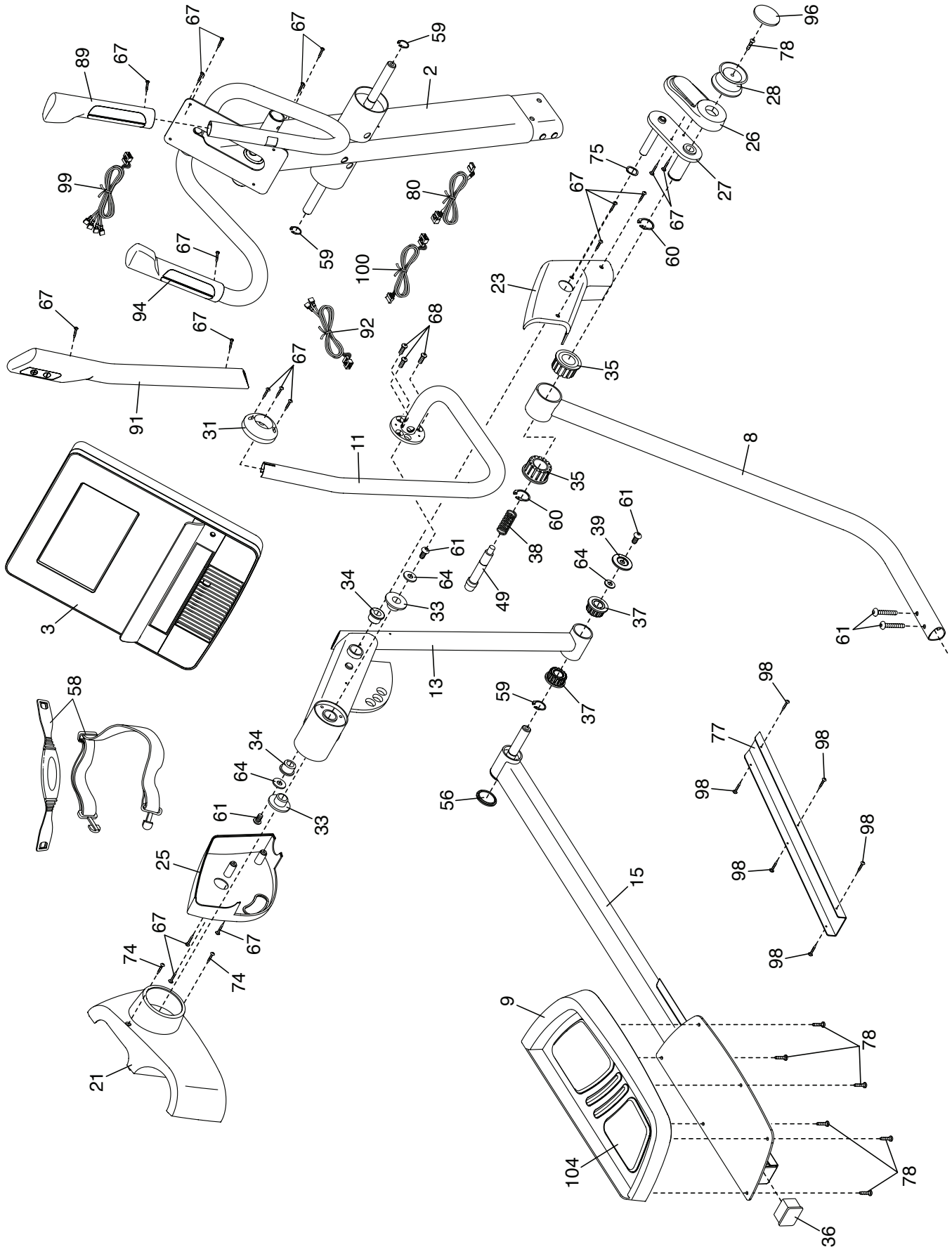

EXPLODED DRAWING C

Model No. NTEL71612.3 R0813A

