

EXPLODED DRAWING A

Model No. NTEL71613.3 R0416A

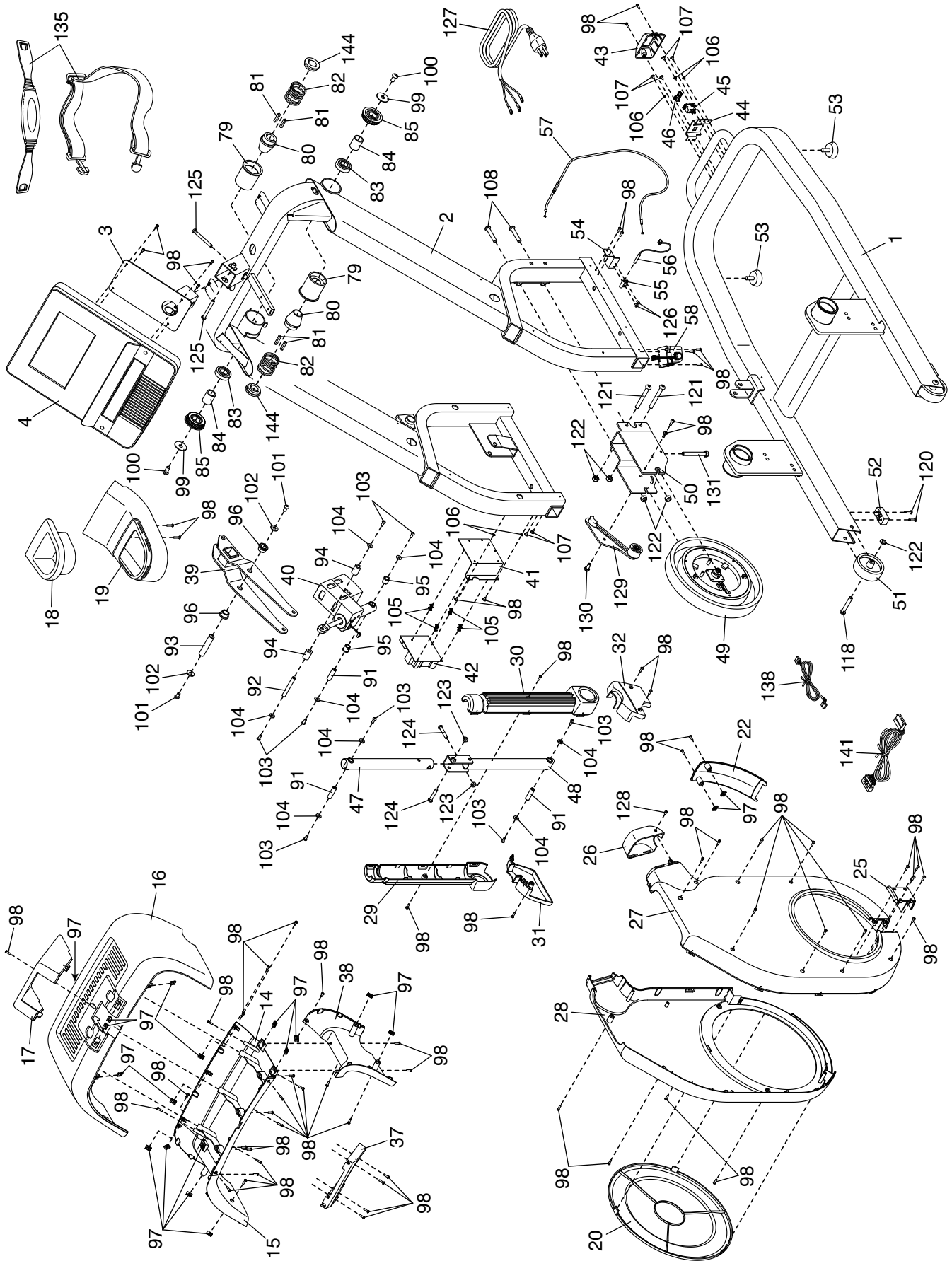

EXPLODED DRAWING B

Model No. NTEL71613.3 R0416A

