

# EXPLODED DRAWING A

Model No. NTEL71613.4 R0916A

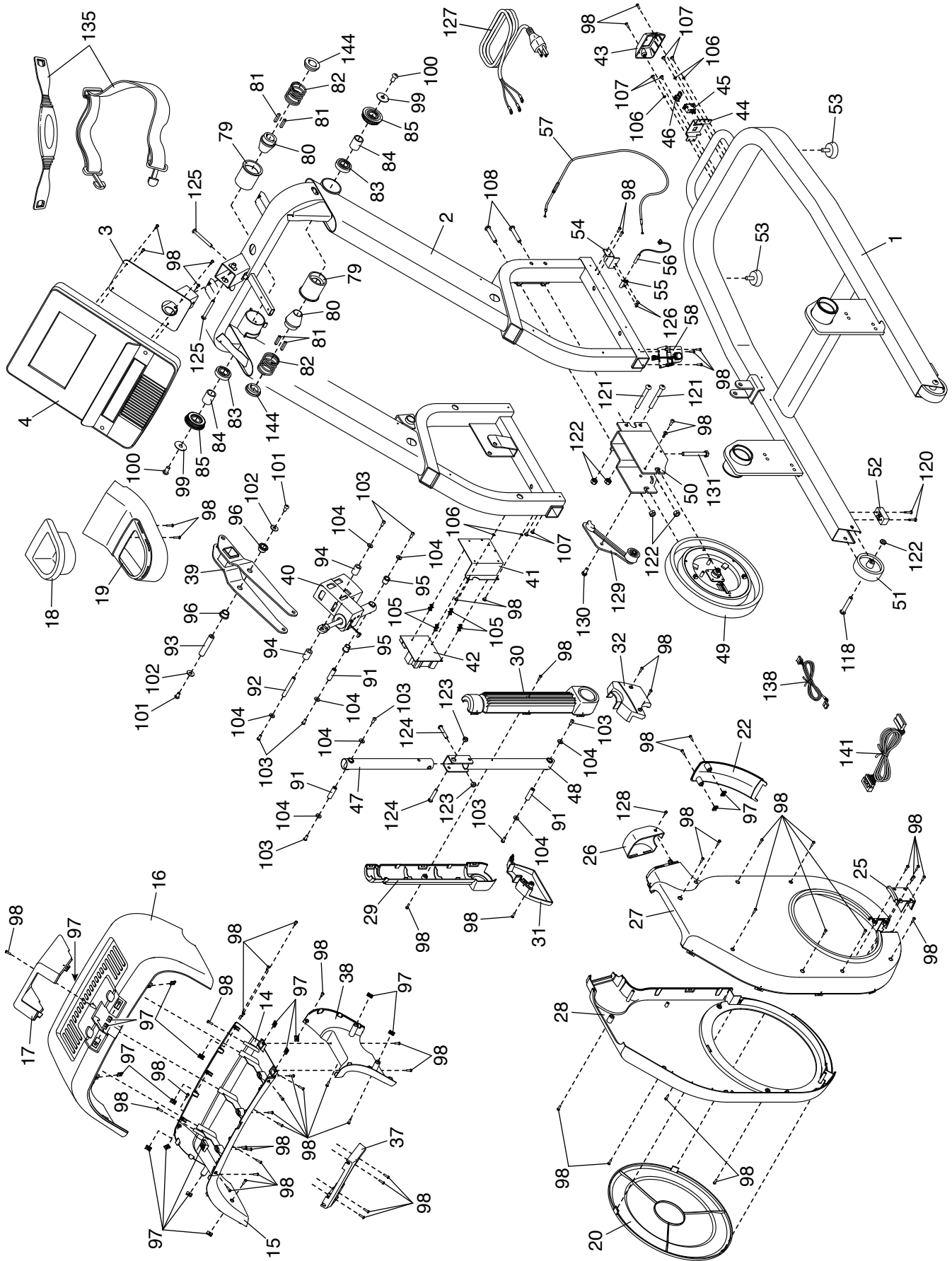

# EXPLODED DRAWING B

Model No. NTEL71613.4 R0916A

