

EXPLODED DRAWING A

Model No. NTEL71618.6 R0420A

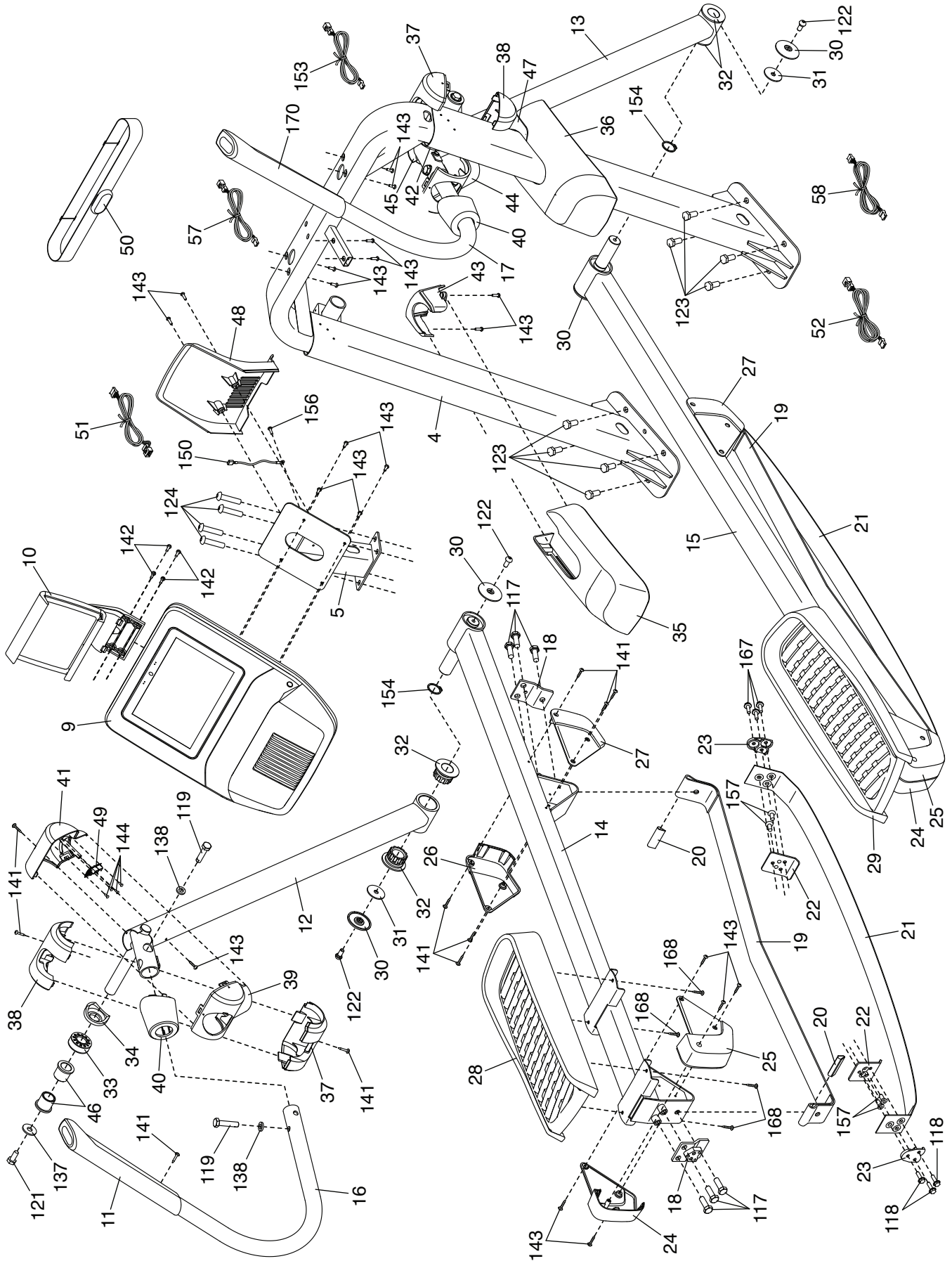

EXPLODED DRAWING B

Model No. NTEL71618.6 R0420A

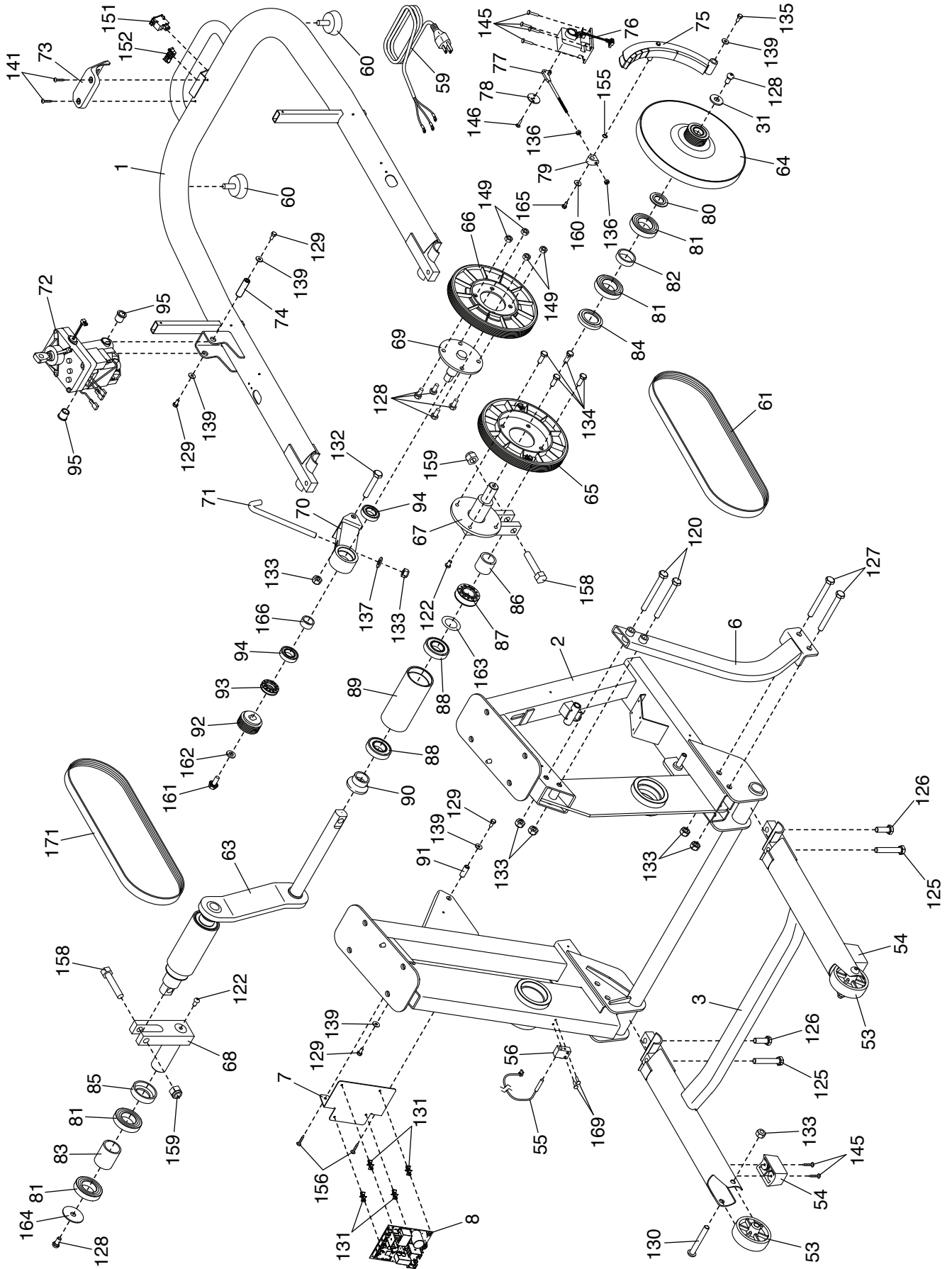

EXPLODED DRAWING C

Model No. NTEL71618.6 R0420A

