

EXPLODED DRAWING A

Model No. NTEL79820.0 R1019A

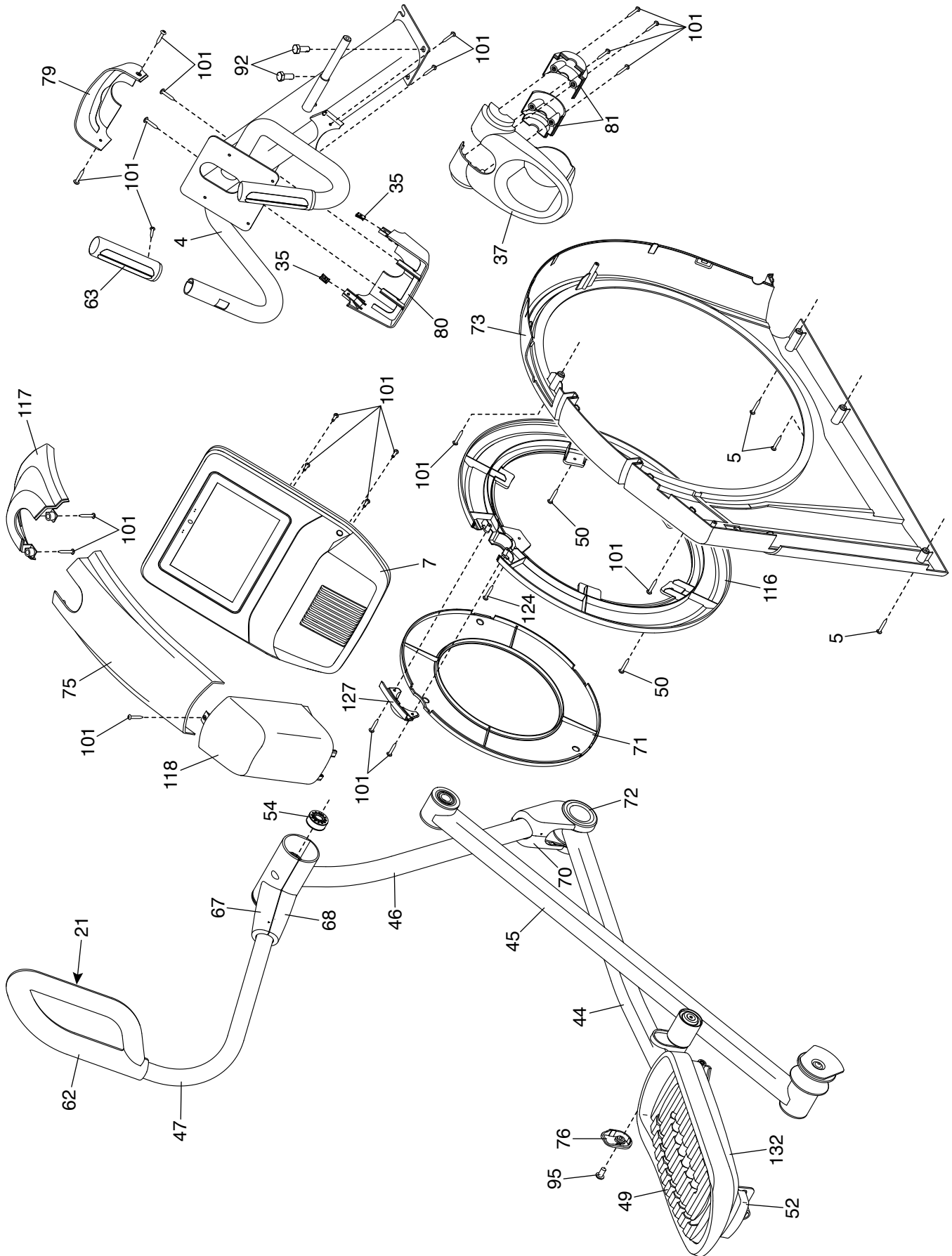

EXPLODED DRAWING B

Model No. NTEL79820.0 R1019A

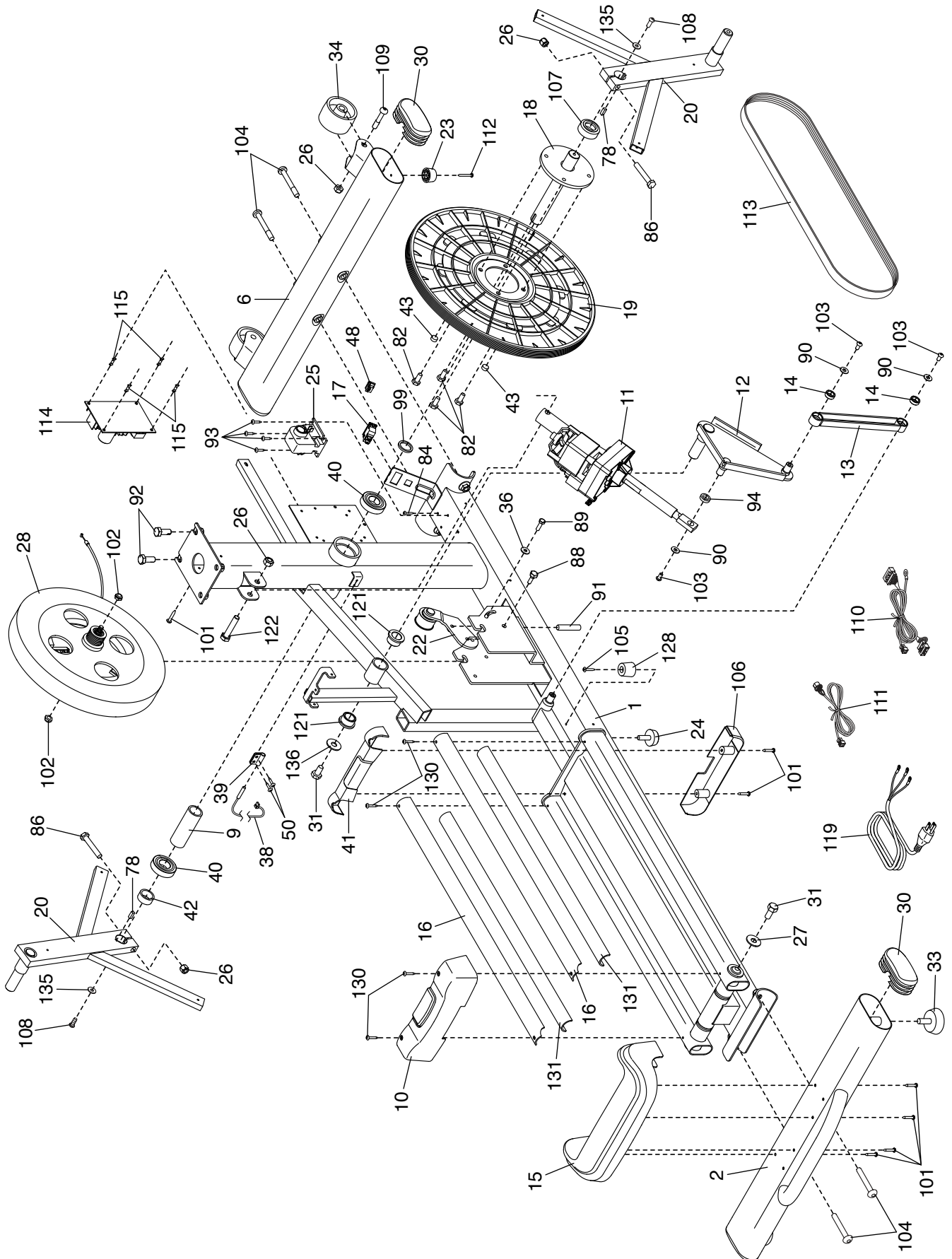

EXPLODED DRAWING C

Model No. NTEL79820.0 R1019A

