

# EXPLODED DRAWING A

Model No. NTEL79820.3 R0421A

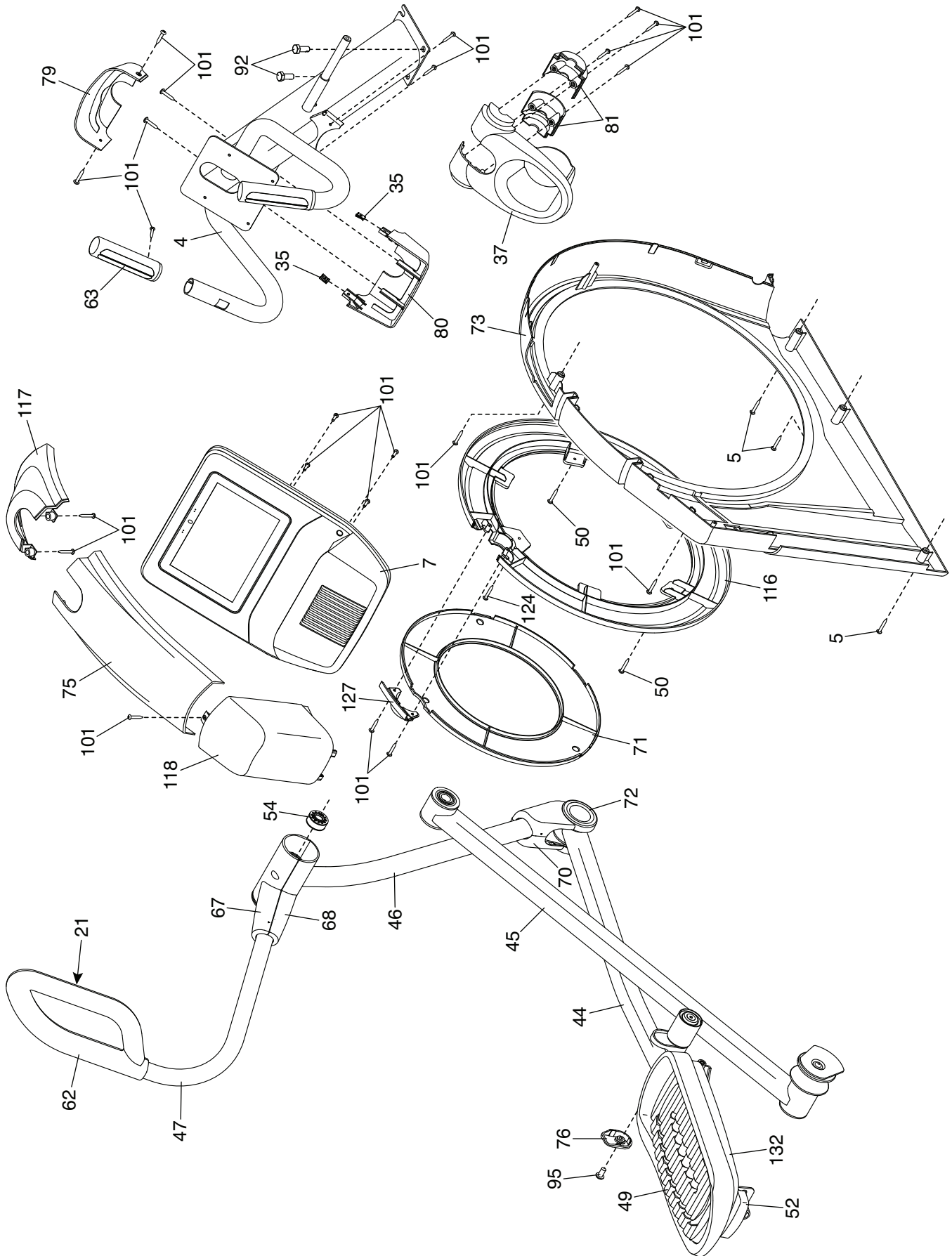

# EXPLODED DRAWING B

Model No. NTEL79820.3 R0421A

