

EXPLODED DRAWING A

Model No. NTEL79820.6 R0521A

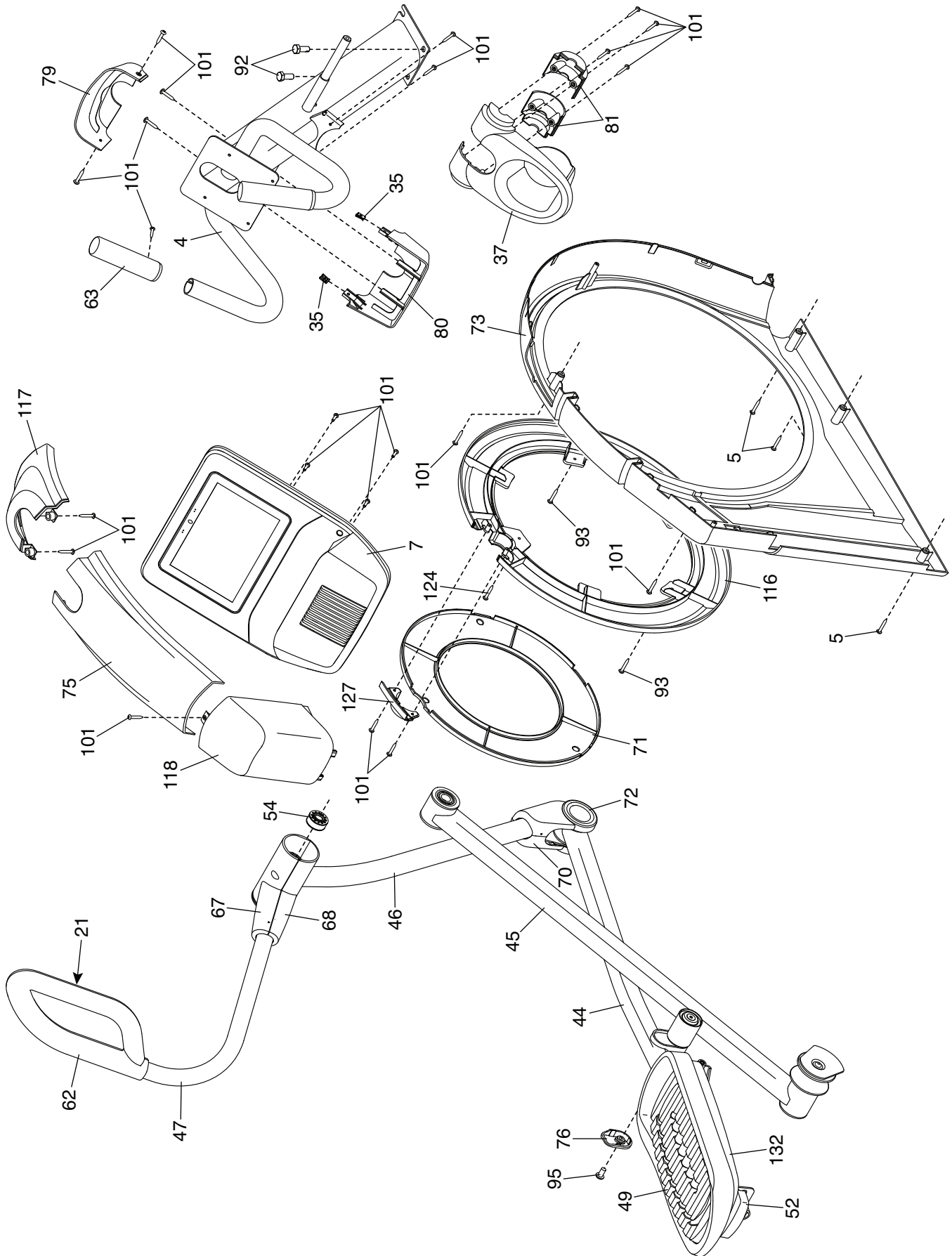

EXPLODED DRAWING B

Model No. NTEL79820.6 R0521A

