

# EXPLODED DRAWING A

Model No. NTEVEL99913.0 R0313A

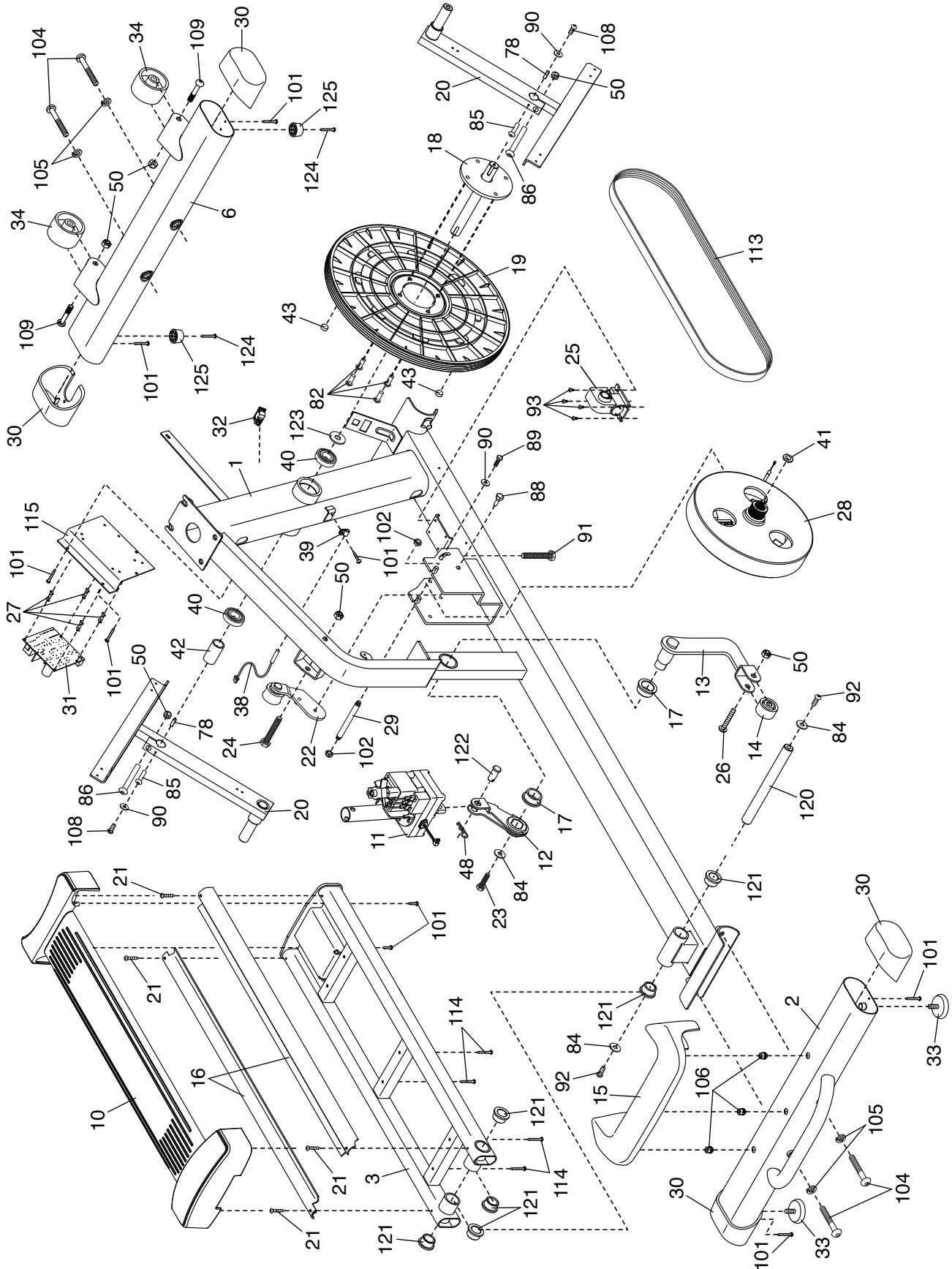

# EXPLODED DRAWING B

Model No. NTEVEL99913.0 R0313A

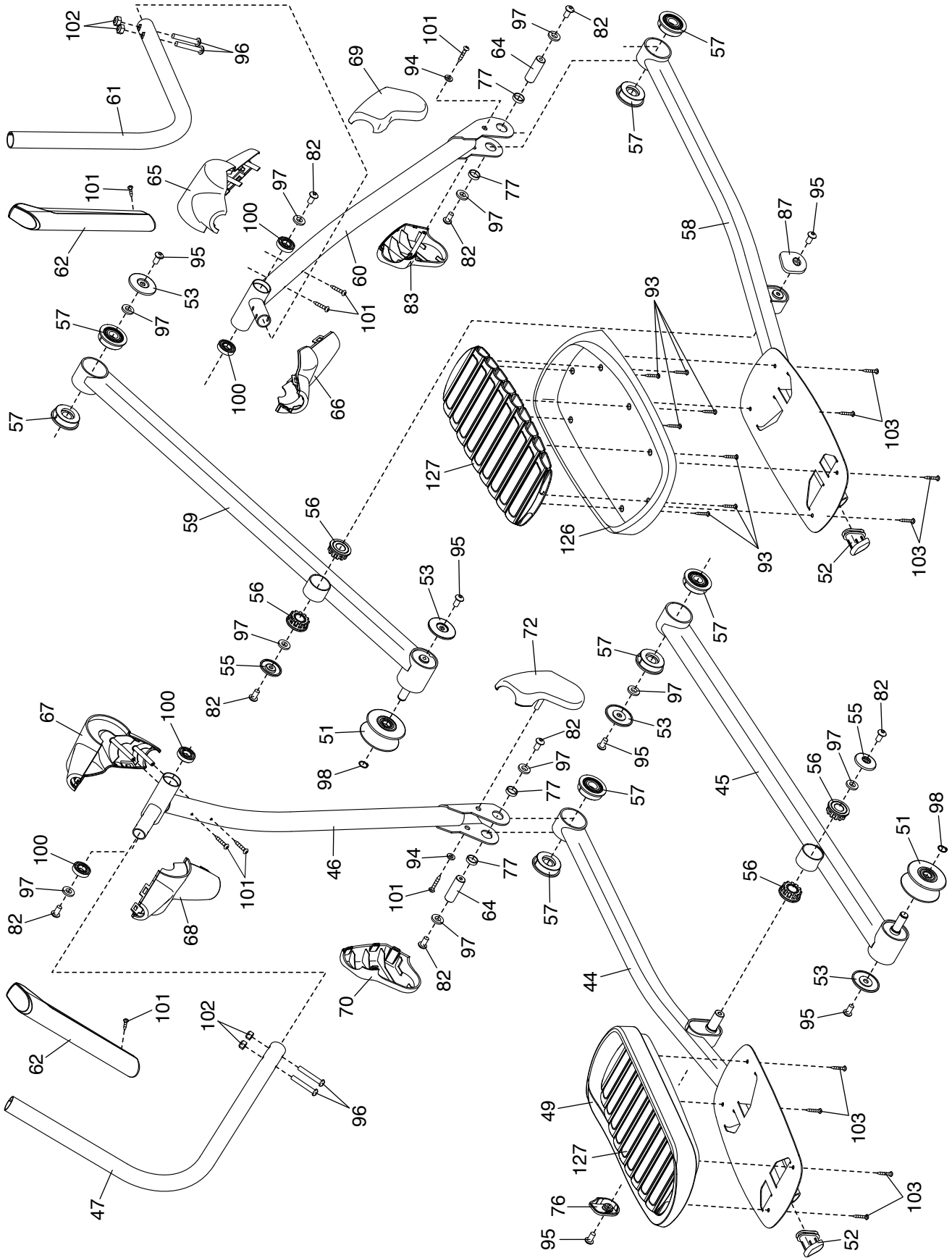

# EXPLODED DRAWING C

Model No. NTEVEL99913.0 R0313A

