

EXPLODED DRAWING A

Model No. NTEVEL99915.3 R1016A

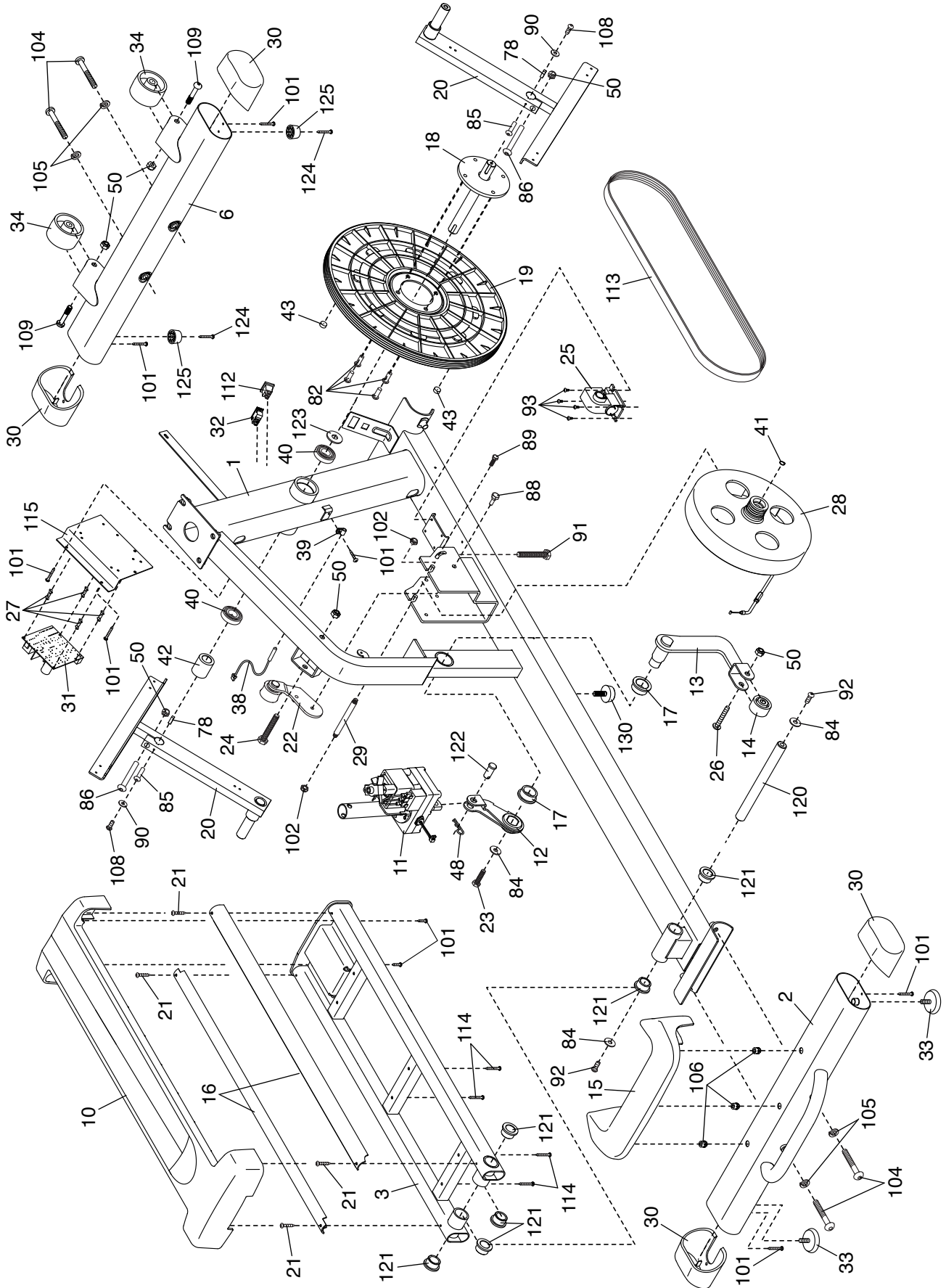

EXPLODED DRAWING B

Model No. NTEVEL99915.3 R1016A

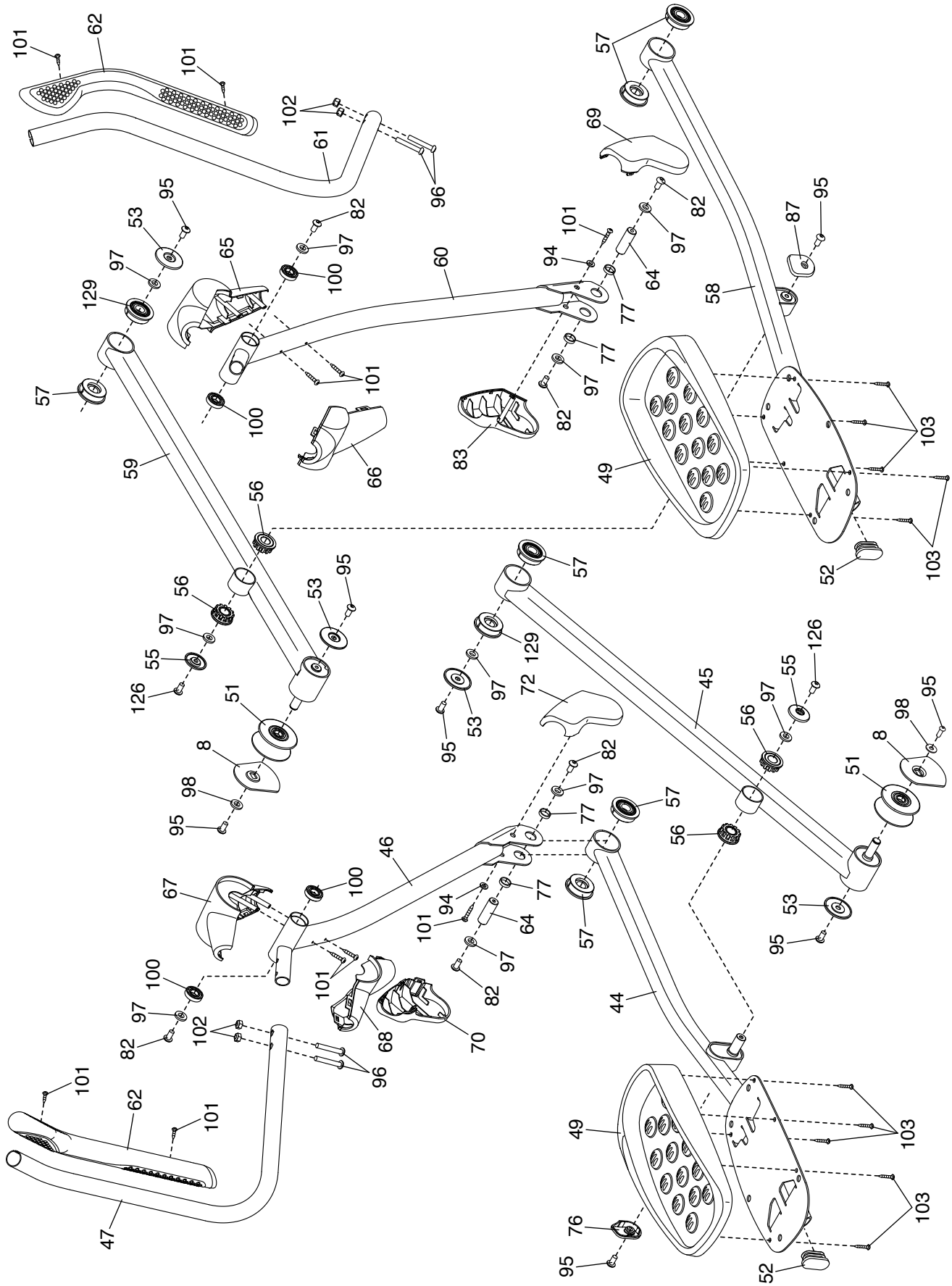

EXPLODED DRAWING C

Model No. NTEVEL99915.3 R1016A

