

EXPLODED DRAWING A

Model No. NTEX02117NB.11 R1220A

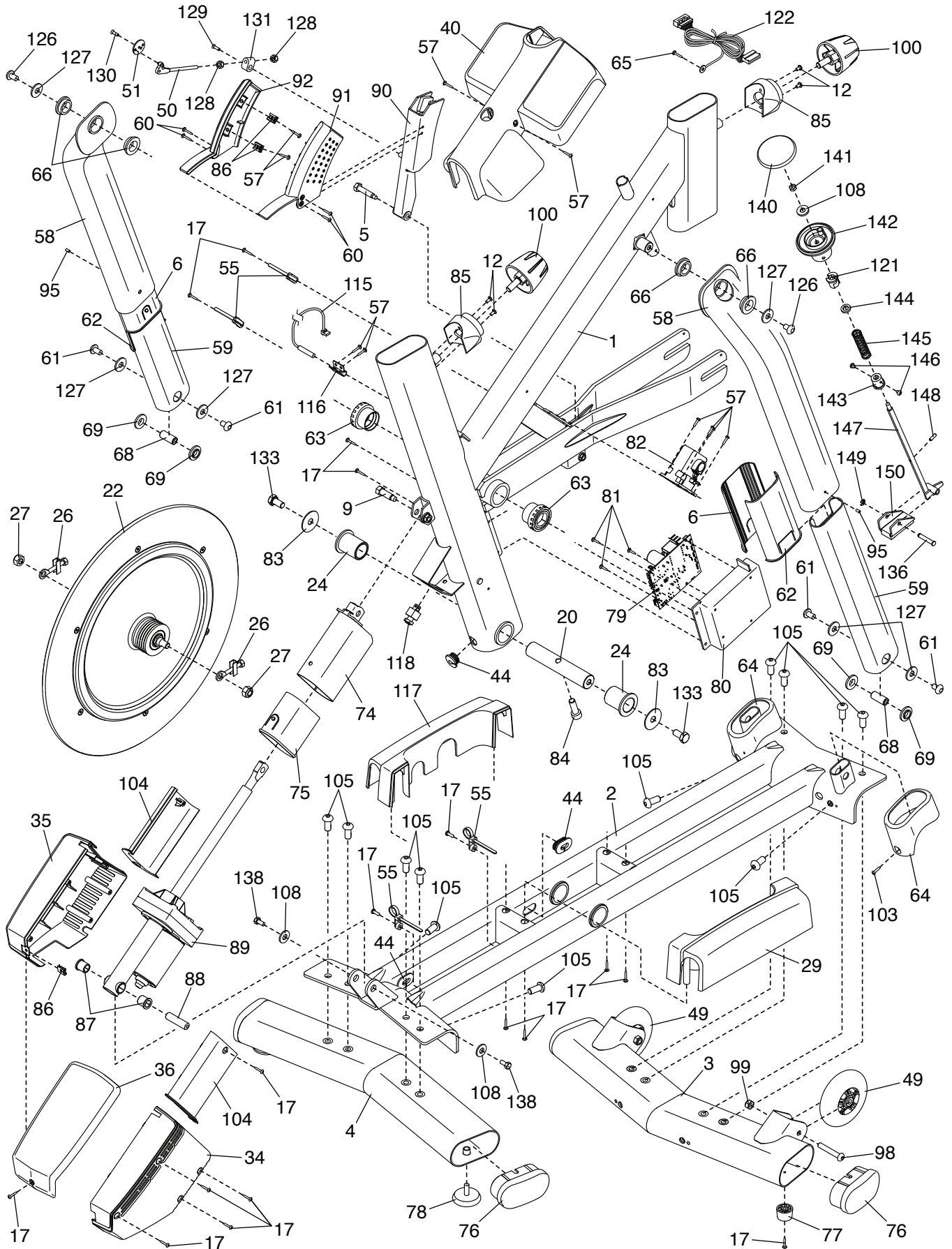

EXPLODED DRAWING B

Model No. NTEX02117NB.11 R1220A

