

EXPLODED DRAWING A

Model No. NTEX05117NB.0 R1219A

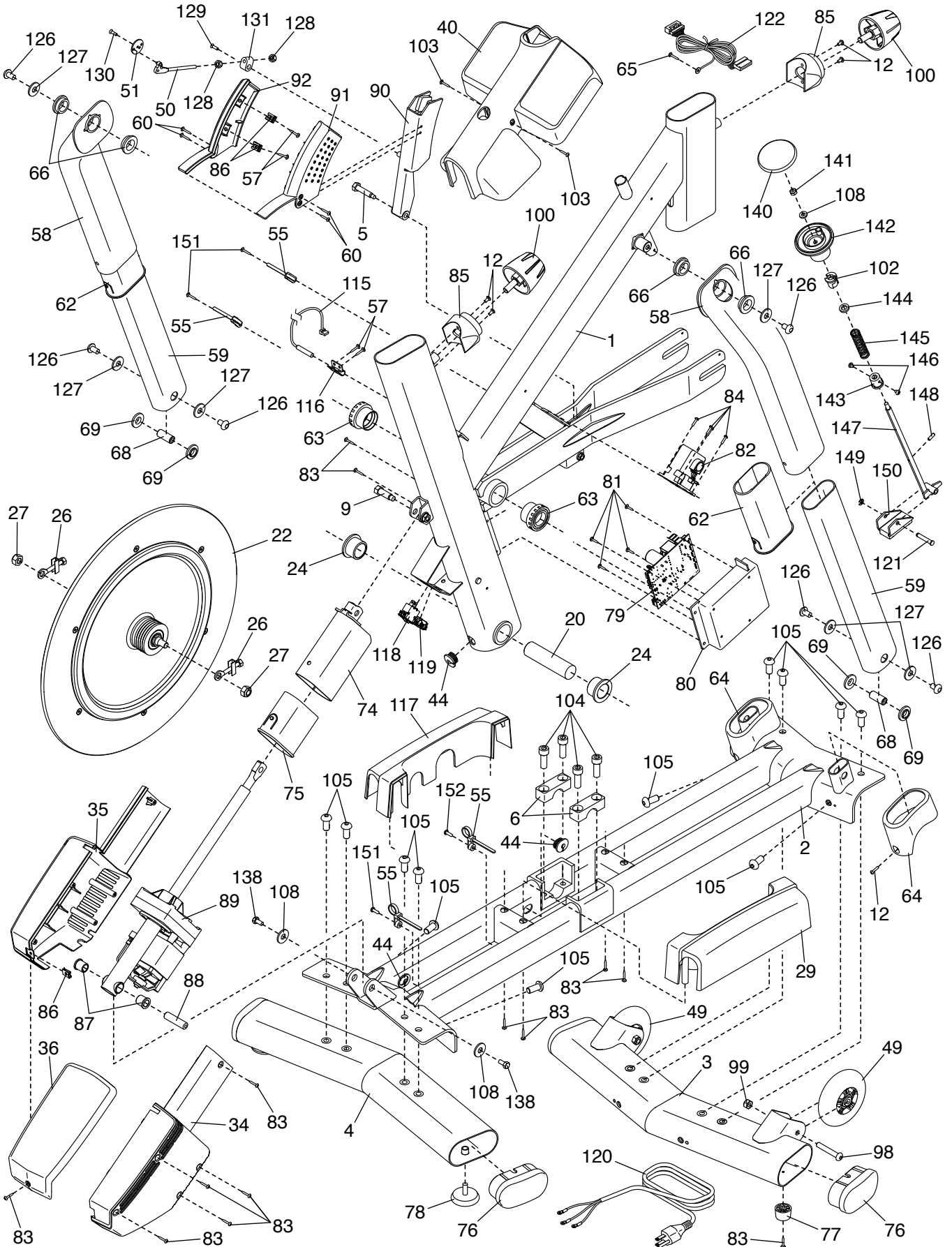

EXPLODED DRAWING B

Model No. NTEX05117NB.0 R1219A

