

EXPLODED DRAWING A

Model No. NTEX05119.0 R1218A

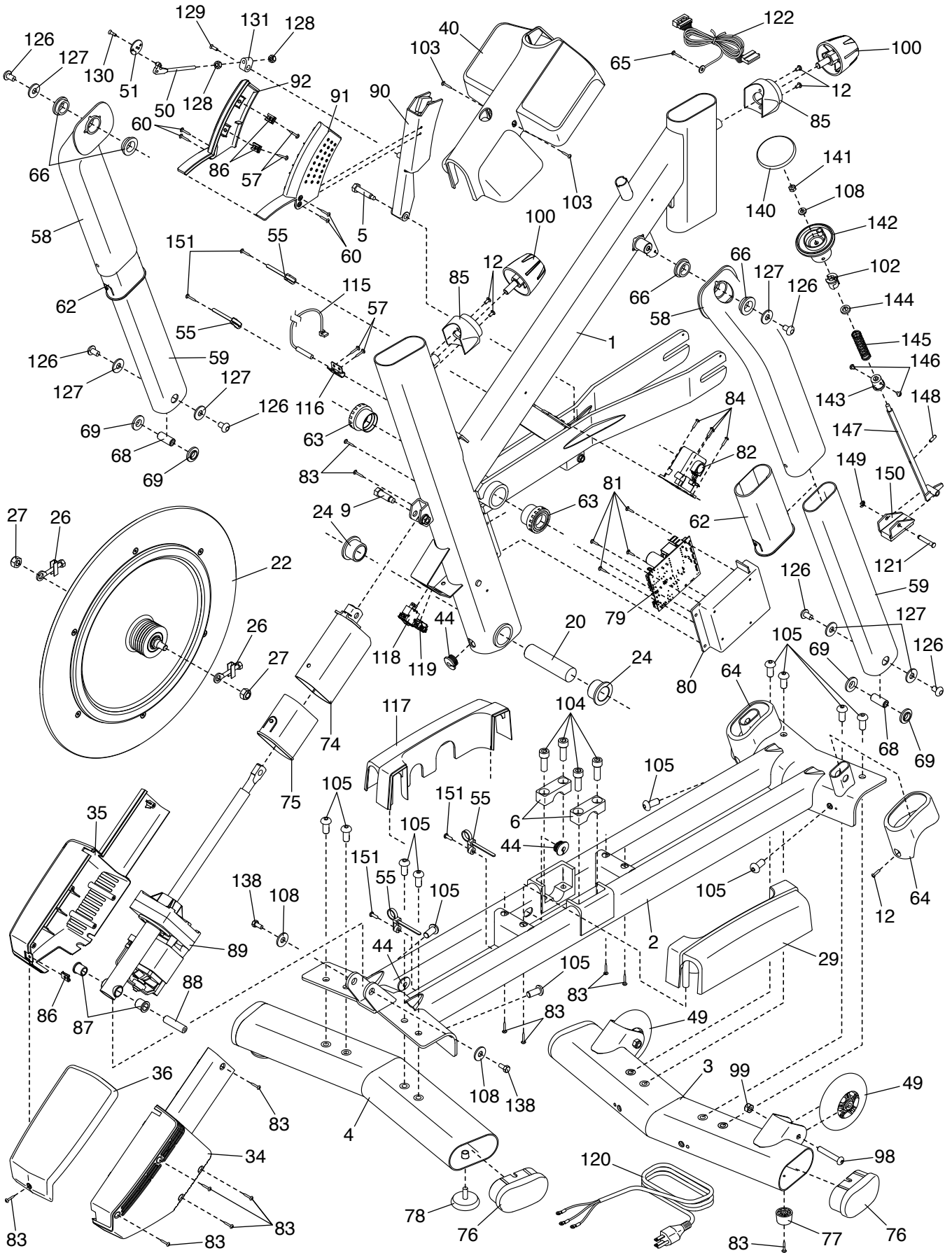

EXPLODED DRAWING B

Model No. NTEX05119.0 R1218A

