

EXPLODED DRAWING A

Model No. NTEX05119.1 R0220A

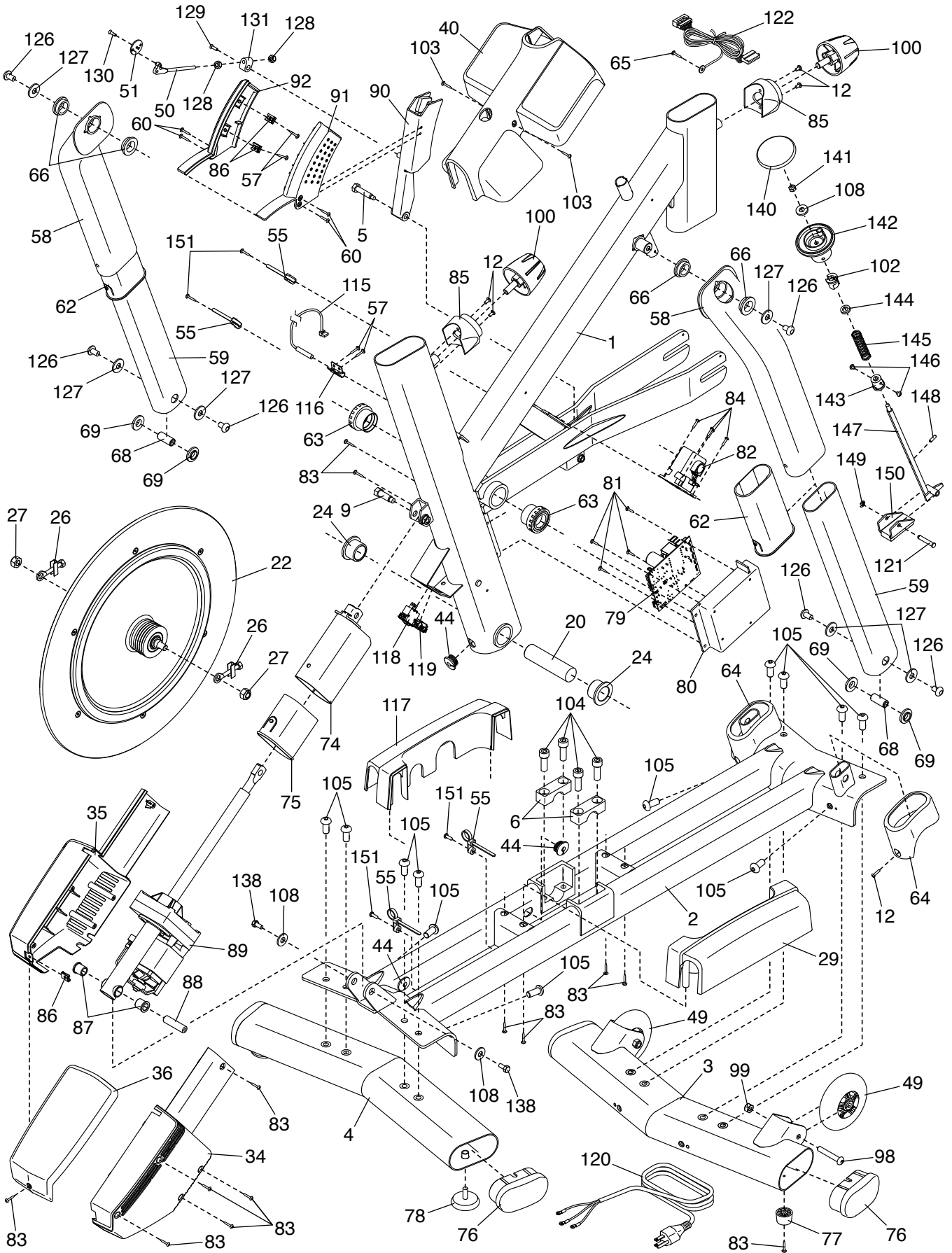

EXPLODED DRAWING B

Model No. NTEX05119.1 R0220A

