

EXPLODED DRAWING A

Model No. NTEX08011.0 R0112A

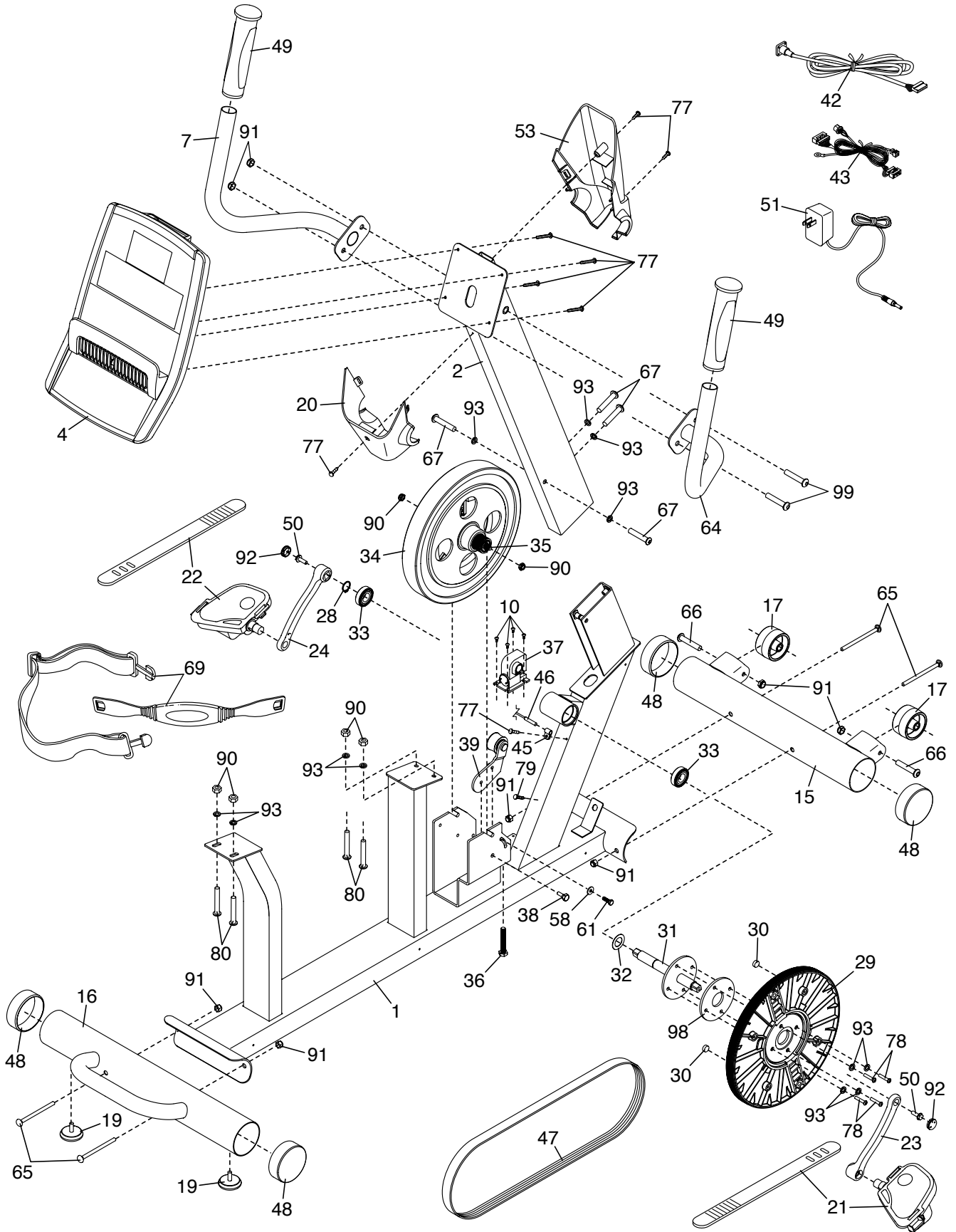

EXPLODED DRAWING B

Model No. NTEX08011.0 R0112A

