

EXPLODED DRAWING A

Model No. NTEX13808.1 R1112A

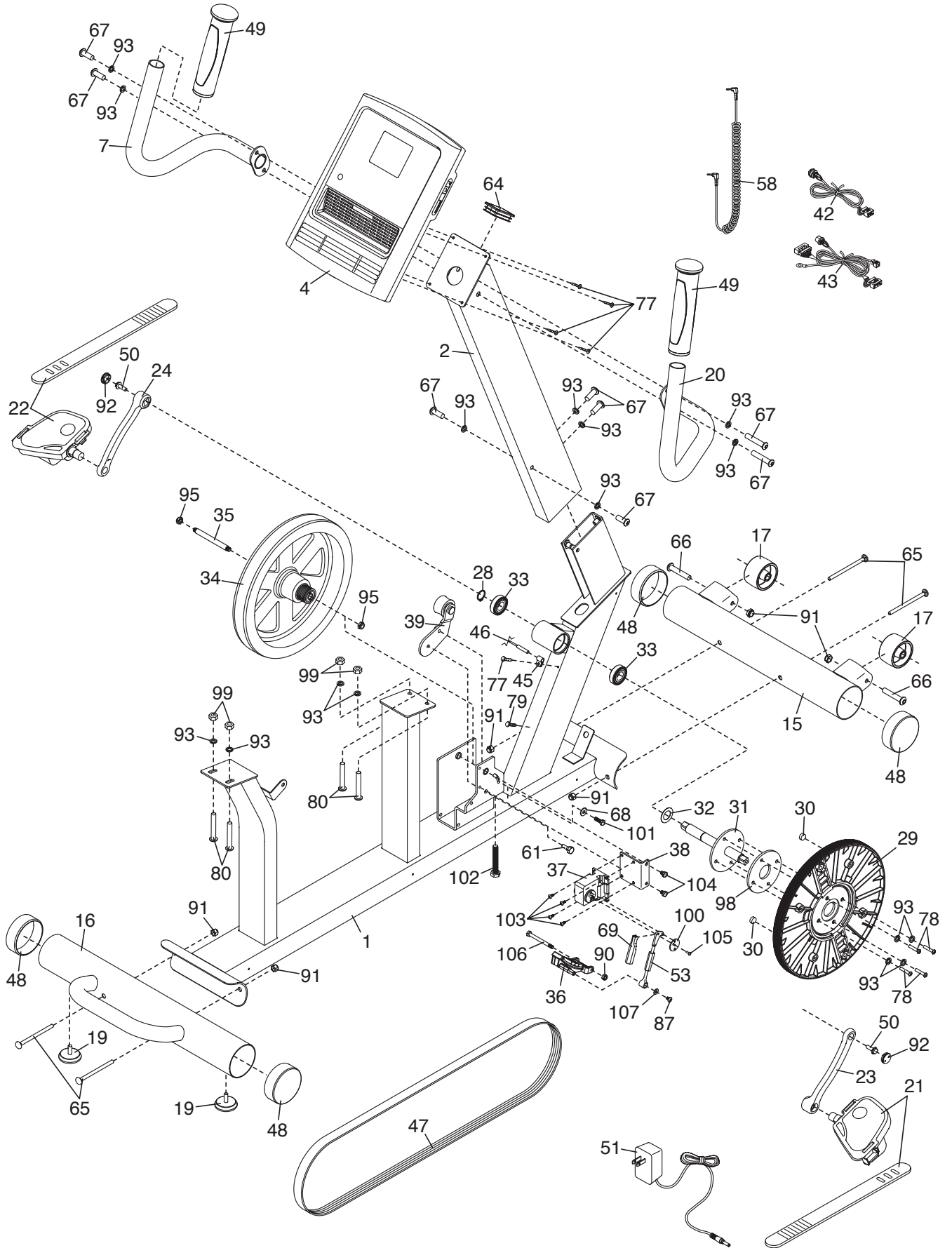

EXPLODED DRAWING B

Model No. NTEX13808.1 R1112A

