

EXPLODED DRAWING A

Model No. NTEX14921.0 R1120A

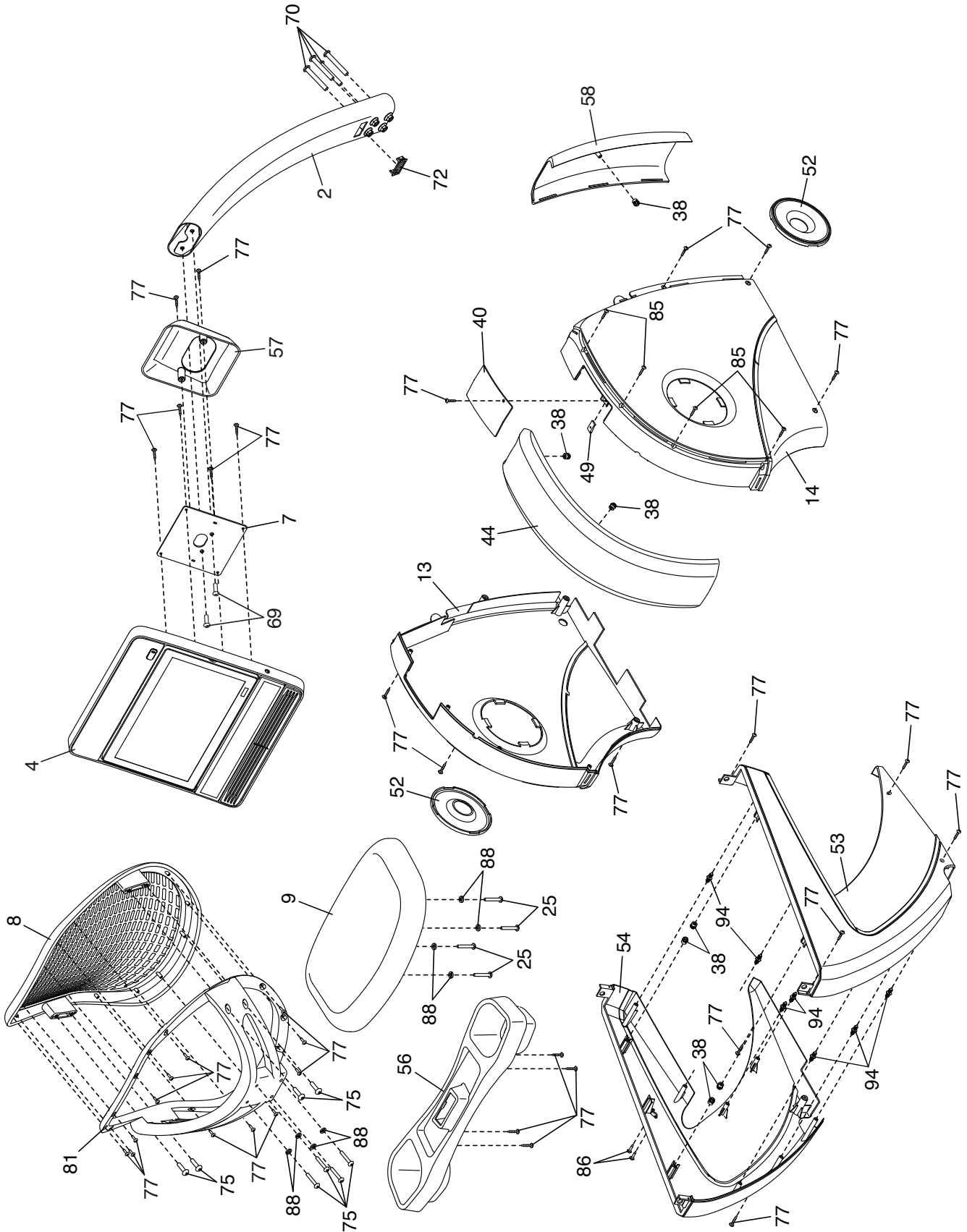

EXPLODED DRAWING B

Model No. NTEX14921.0 R1120A

