

# EXPLODED DRAWING A

Model No. NTEX14921.2 R1123A

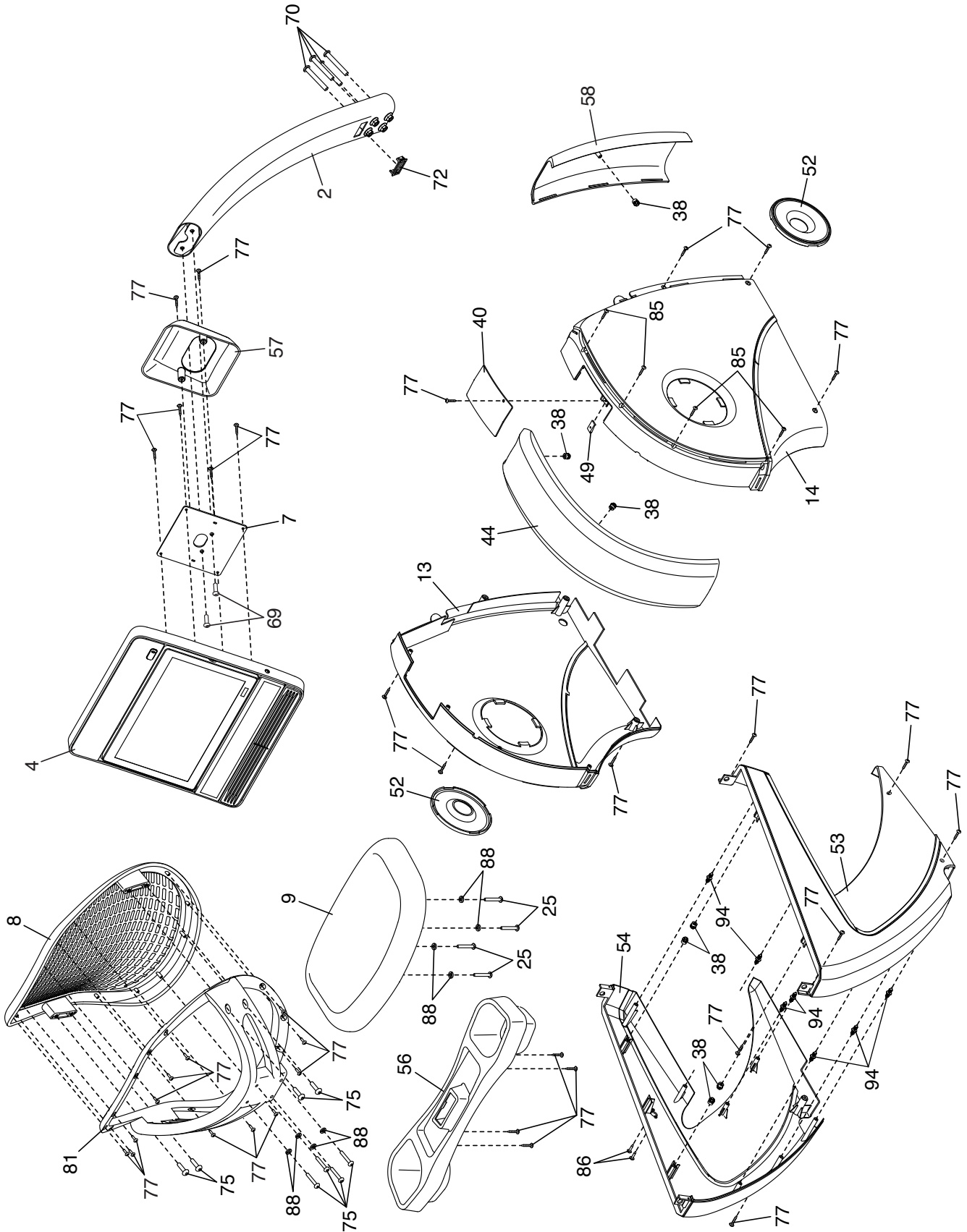

# EXPLODED DRAWING B

Model No. NTEX14921.2 R1123A

