

EXPLODED DRAWING A—Model No. NTEX4196.2

R0208A

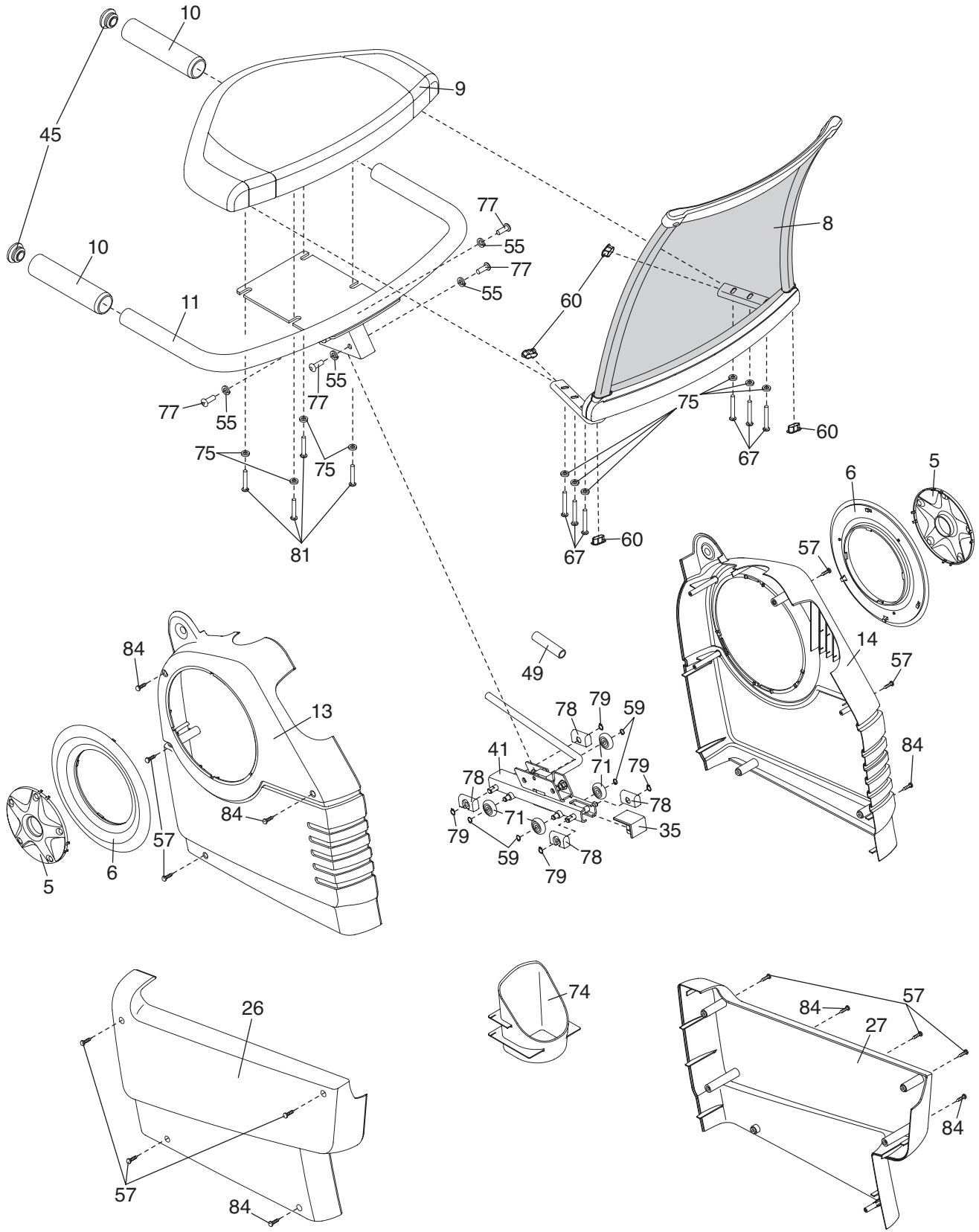

EXPLODED DRAWING B—Model No. NTEX4196.2

R0208A

