

EXPLODED DRAWING A—Model No. NTEX4196.3

R0408A

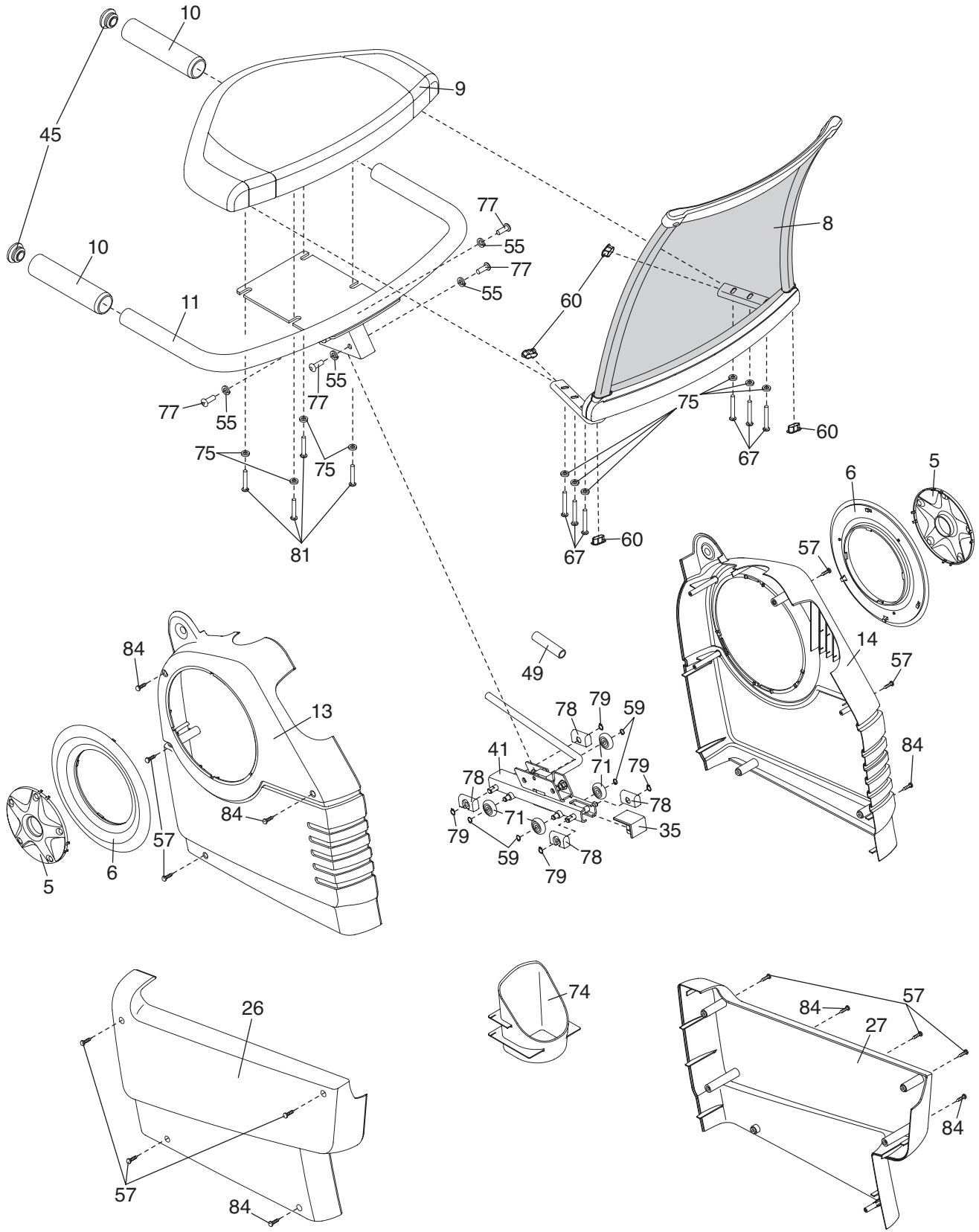

EXPLODED DRAWING B—Model No. NTEX4196.3

R0408A

