

EXPLODED DRAWING A—Model No. NTEX73908.0

R0809A

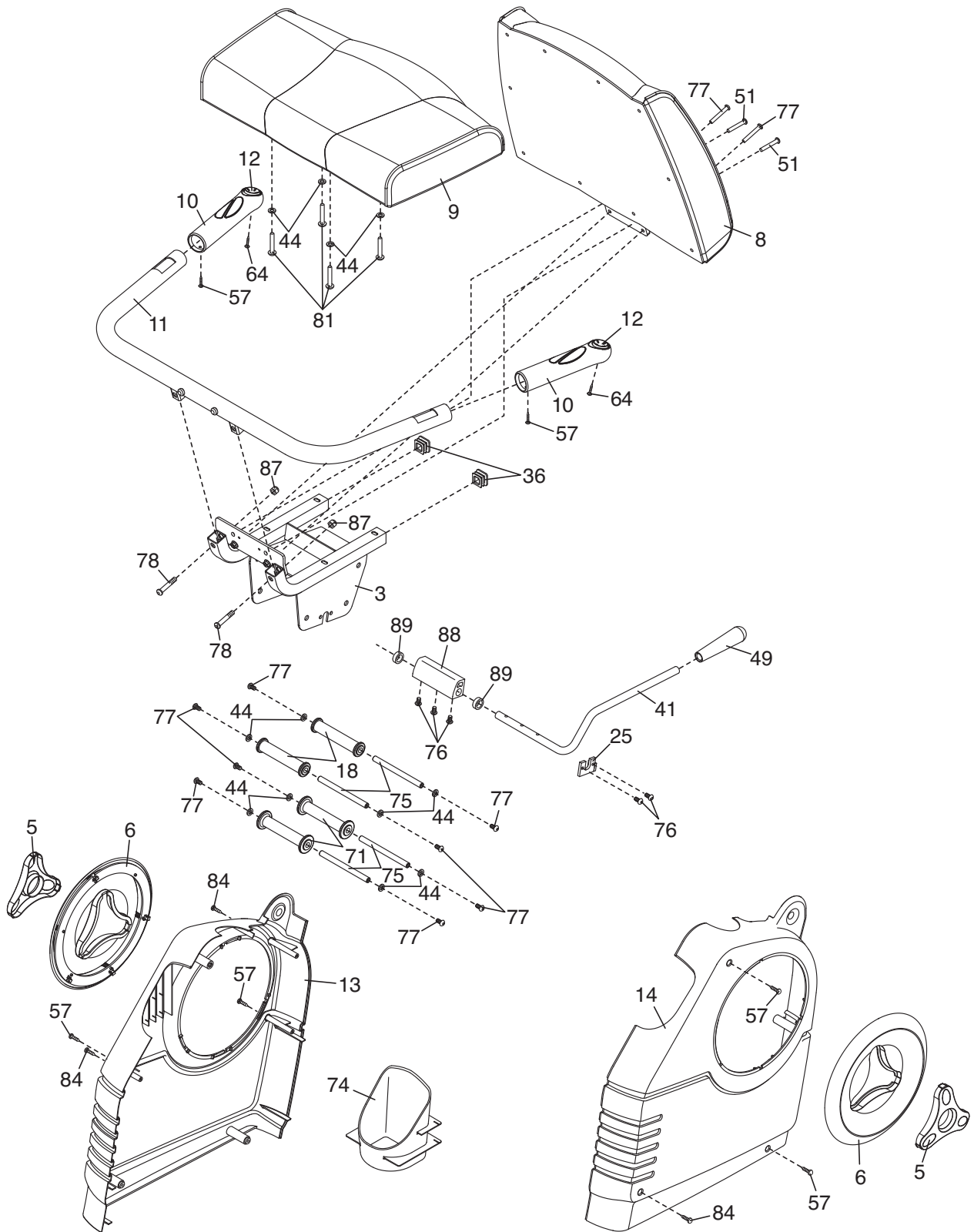

EXPLODED DRAWING B—Model No. NTEX73908.0

R0809A

