

EXPLODED DRAWING A

Model No. NTEX75016.2 R0118A

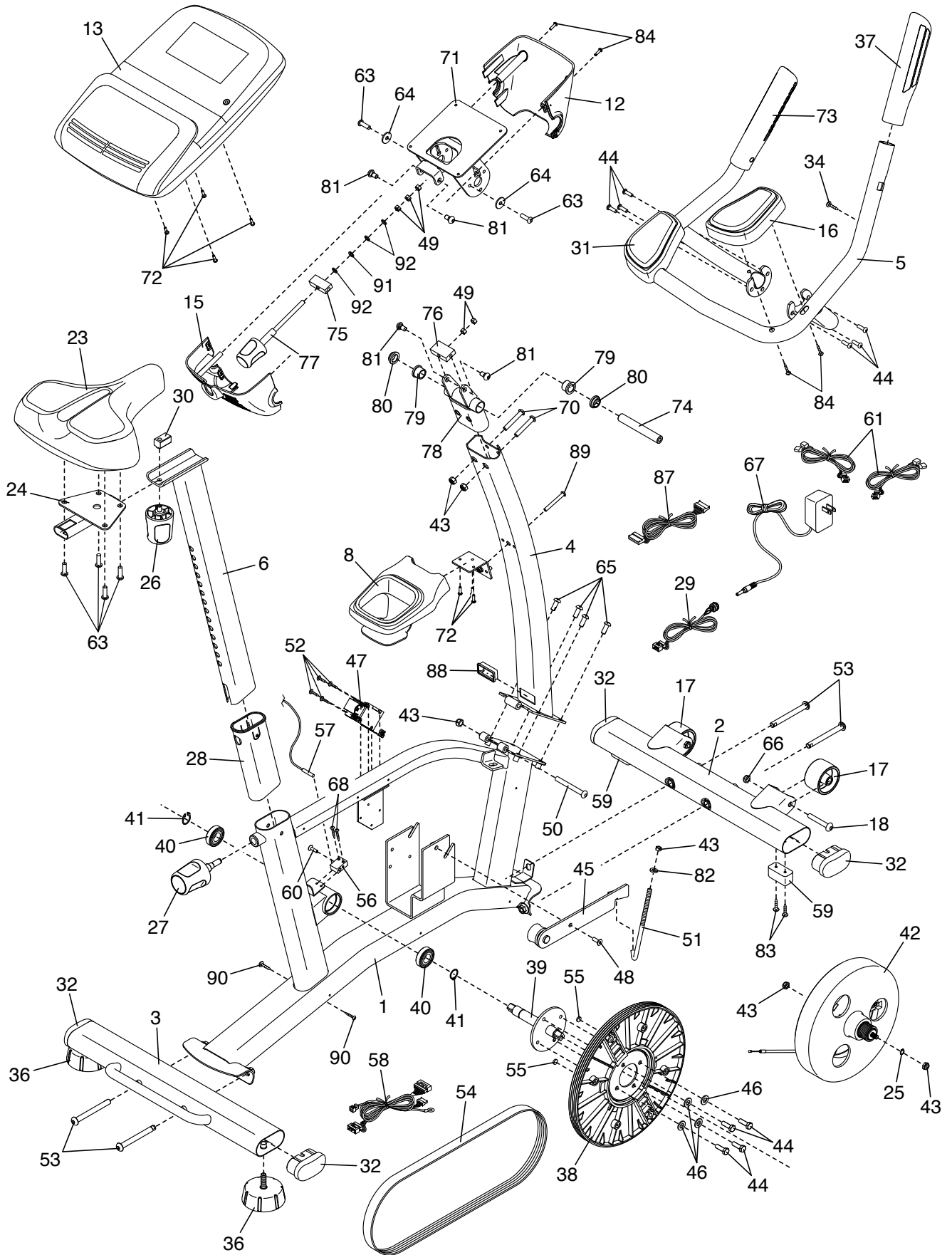

EXPLODED DRAWING B

Model No. NTEX75016.2 R0118A

